

ROBUS[®]

ROBUS VEGAS LED FLEXI-STRIP

LED flexi-strip lighting made to measure

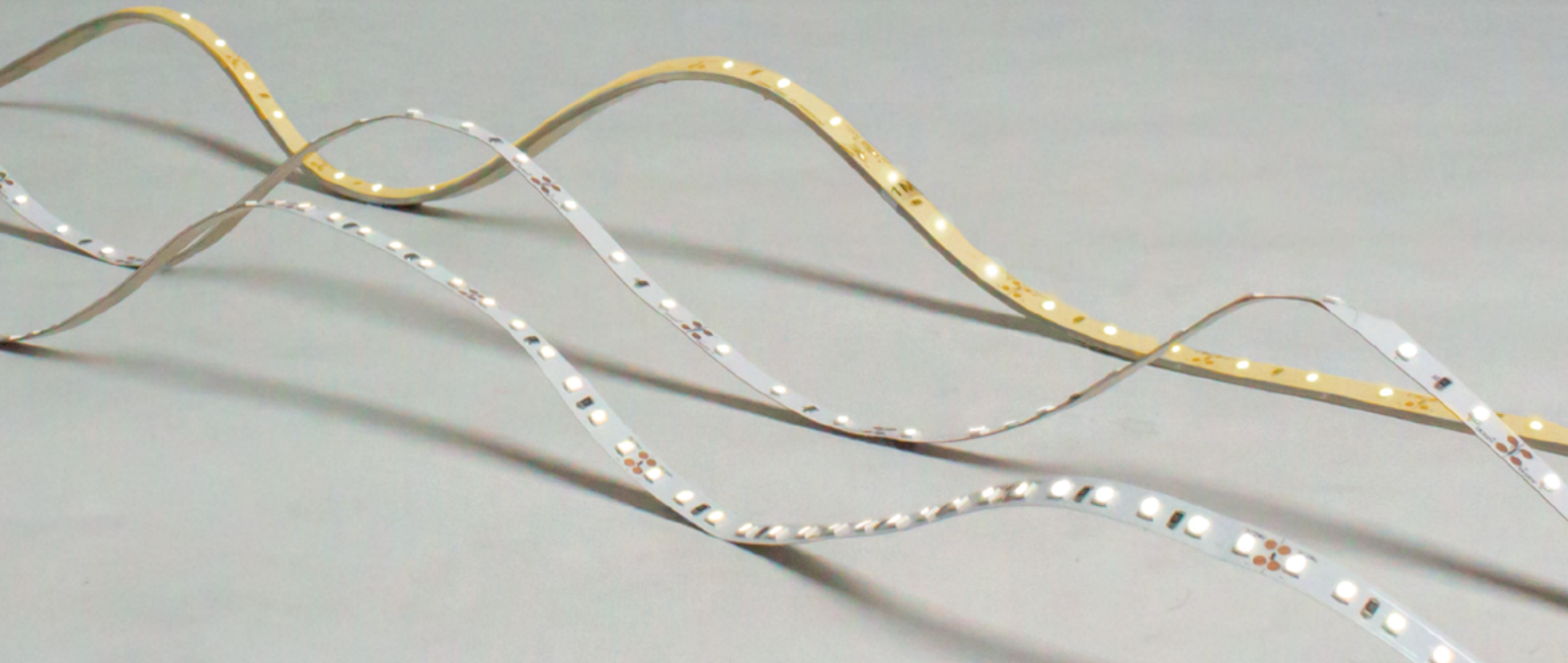

CONTENTS

INTRODUCING VEGAS LED FLEXI-STRIP	2
VEGAS IP20 LED FLEXI-STRIP	12
VEGAS IP67 LED FLEXI-STRIP	28
VEGAS CONTROLLERS & AMPLIFIERS	44
VEGAS DRIVERS	50
VEGAS ALUMINIUM EXTRUSIONS	58



GETTING STARTED



WHAT IS LED STRIP LIGHTING?

An LED strip light is a flexible circuit board that is populated with LEDs that you can put almost anywhere to add a powerful lighting effect in a variety of colors and levels of brightness.

The basics are all similar. You will need an LED strip light, driver (sometimes called a power supply) and a way to attach the two to make your lights turn on.

The size and type of driver you need will depend on the type of LED strip light and the length and dimming options required.



Have a clear vision! Because each project is unique, there is no all-in-one solution. Different projects require different types of LED strips.

Before you order an LED strip, check the below:

- What will you be lighting?
- Where will it be installed?
- Do you want to dim your lights or control them with a remote?
- What overall look do you want to achieve?
- What colour do you need?
- Are there other lights in the area and if so, what colour are they?

TOP 5 THINGS YOU NEED TO KNOW BEFORE CHOOSING LED FLEXI-STRIP

1.

COMPARE LUMEN OUTPUT AND CCT COLOUR

Lumen is the measurement of brightness as perceived by the human eye. Different projects require a certain amount of brightness to achieve a desired look.

Below is a general guide. We are always available to help design your project with you.

CCT (Correlated Colour Temperature) refers to the color temperature of light, measured in degrees Kelvin (K).

The temperature rating directly affects what the white light will look like. Your choice of light colour will depend on the effect that is required for each project.

See below left examples on same different light colour temperature.

EXAMPLE OF CCT



Warm
(3000K)

Neutral
(4000K)

Daylight
(6500K)

EXAMPLE APPLICATION	LUMEN REQUIRED / FOOT OF LED STRIP
ACCENT LIGHTING & MOOD LIGHTING	~156 - 350
UNDER CABINET LIGHTING	~175 - 525
TASK LIGHTING WITH LOW DISTANCE FROM LIGHT SOURCE	~280 - 437
TASK LIGHTING WITH HIGHER DISTANCE FROM LIGHT SOURCE	~344 - 687
INDIRECT LIGHTING IN A BEDROOM / HOTEL / VEHICLE / LOBBY	~375 - 562
INDUSTRIAL LIGHTING / SIGNAGE / TUBE REPLACEMENTS	~500 - 950

2.

COMPARE LED STRIP SIZE AND NUMBER OF LEDS ON THE STRIP

The different numbers correlate to the different physical dimensions of the chip. The numbers 5050, 3528, 2835, etc. correlate to the size of the chip in millimeters. Some LEDs are brighter than others and some give off more light per watt.

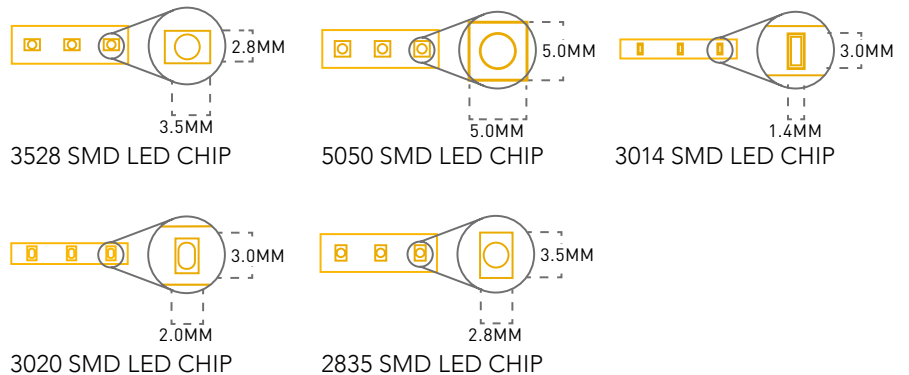

VEGAS LED STRIPLIGHTS USE:



SMD 5050

These LED chips are called SMD 5050 because the dimensions of the chips are 5.0mm x 5.0mm. They have 3 LED diodes in one housing (sometimes called tri-chips) and are a lot brighter than individual 3528 LED chips. They are used when you need slight illumination for your project area and especially RGB (Red Green Blue) colour changing lights.



SMD 2835

They are called SMD2835 because the dimension of the chip is 2.8mm * 3.5mm. This type is a new choice on the LED market as a more efficient replacement for the 5050 – producing 20% more light but drawing less wattage.

TOP 5 THINGS YOU NEED TO KNOW BEFORE CHOOSING LED FLEXI-STRIP

3.

COMPARE LED STRIP SIZE AND NUMBER OF LEDS ON THE STRIP

WHAT DO THE NUMBERS OF THE LED CHIPS MEAN?

Common LED densities are 30/60/120 LEDs per meter. The total light output of an LED strip is simply the sum of the light output from the individual LEDs on the LED strip. So therefore, LED density has a direct impact on the total amount of light output. The more LEDs per meter, the more light per meter (when comparing situations where the LED is the same).

What is more, LED density affects light distribution. Because the LEDs are individual “point sources” depending on how they are installed, the

individual LEDs on an LED strip may create a “dotted” effect or what is also sometimes called “spotting.” A higher density LED strip will have a lower chance of “spotting” and the individual LEDs cannot be seen.

Power draw and light output are roughly proportional, so the same logic as LED density’s effect on light output also applies to power draw. Simply put, higher LED density LED strips will draw more power, assuming we are comparing two strips with the same LEDs, each drawing the same amount of power.

30 LED/M



60 LED/M



120 LED/M



4.

COMPARE WATTAGE
CONSUMED PER STRIP OF LEDS
AND OPERATING VOLTAGE

Wattage tells us how much power we are consuming while these lights are on and in turn how much we'll have to pay at the end of each month. When comparing different LED Strip be sure to verify if the wattage is given per meter or reel before you buy.

An LED strip light that uses 24 Volts will not work if you purchase a 12 Volt driver and may also result in risk of fire.

You need to choose the correct power unit for your lights.

5.

COMPARE VERIFIABLE
QUALITY

You are looking for a "fit- and-forget" lighting system that can be used for years to come.

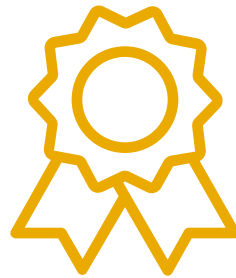

SAFETY CERTIFICATIONS

Check the CE / UL listing or RoHS registry to make sure the LEDs are safe and do not contain lead or other hazardous materials.



TEST REPORTS

Ask for test reports to verify claims of brightness and longevity. These may include LM-80 testing, IES files, etc.



WARRANTY, CUSTOMER SERVICE, AND INSTALLATION/ DESIGN ASSISTANCE

Ask for help with your project

HOW TO CHOOSE A POWER SUPPLY FOR YOUR LED FLEXI-STRIP PROJECT

1.

DETERMINE THE LED FLEXI-STRIP VOLTAGE

The first step is to figure out what the voltage of the LED flexi-strip is. The majority of LED flexi-strip available on the market run at 12V DC and are used mainly for domestic use. Others are primarily at 24V DC and used for commercial applications.

Voltage is usually listed on the LED flexi-strip spec sheet and on the packaging. If you don't have access to any of those, another way to confirm this is to look at the LED flexi-strip PCB. Most LED flexi-strip will have a mark showing 12V or 24V.



Then, check if the voltage on the driver / power supply specifications matches the LED strip.

2.

DETERMINE THE POWER DRAW OF THE LED FLEXI-STRIP

Look for either a wattage (W) or amperage (A) specification for the LED flexi-strip. This could be listed as either W/m or A/m, or simply W or A.

FOR EXAMPLE:

You see a flexi-strip with the description "**4.8W/m, 12V 5M LED Strip**". The LED strip lists the total wattage as 24 Watts, or 4.8 Watts per meter. This checks out because there are 5 meters per reel and 4.8 Watts/meter * 5 meters = 24 Watts. Although it's not listed here, we can calculate the amperage using the formula:

$$P = V \times I, \text{ where } P \text{ is the wattage, } V \text{ is voltage and } I \text{ is amperage:}$$
$$24 = 12 \times I$$
$$I = 2.0 \text{ Amps}$$

In electrical terms, we now know that at 12V, this LED strip will draw about 24 Watts per reel (5 meters) or about 2.0 Amps.

3.

CHOOSE A DRIVER WITH THE SAME VOLTAGE AND POWER AMPERAGE TO RUN YOUR FLEXI-STRIP

FOR EXAMPLE:

If you would like to use 5m of 4.8W/m, 12V LED flexi-strip in a room, you should use a driver that has a rating of at least 24W.

If the power supply's capacity is higher than the LED flexi-strip's power draw (for example 30W), you can safely pair them together.

However, you should never use driver that's capacity is smaller than max power of LED flexi-strip used, as this will damage the strip.

See below for a safe driver compatibility list for different LED flexi-strip types and lengths (listed min. driver capacity required):

LED STRIP LENGTH (M)	4.8W/M 12V	9.6W/M 24V	12W/M 24V	14.4W/M 24V
1.0m	5W 12V driver	10W 24V driver	12W 24V driver	15W 24V driver
2.0m	10W 12V driver	20W 24V driver	24W 24V driver	30W 24V driver
3.0m	15W 12V driver	30W 24V driver	36W 24V driver	44W 24V driver
4.0m	20W 12V driver	40W 24V driver	48W 24V driver	58W 24V driver
5.0m	25W 12V driver	50W 24V driver	60W 24V driver	72W 24V driver
6.0m	30W 12V driver	60W 24V driver	72W 24V driver	87W 24V driver
7.0m	35W 12V driver	70W 24V driver	84W 24V driver	101W 24V driver
8.0m	40W 12V driver	80W 24V driver	96W 24V driver	116W 24V driver
9.0m	45W 12V driver	90W 24V driver	108W 24V driver	130W 24V driver
10.0m	50W 12V driver	100W 24V driver	120W 24V driver	144W 24V driver



Please note above wattages may not be available on the market, so always round UP to the closest wattage driver.

WHY VEGAS LED STRIPLIGHTING?

TRUST ROBUS
TO SUPPLY
HIGH QUALITY,
RELIABLE
LIGHTING
PRODUCTS

You need a product you can trust, that will produce good, clean light for years to come and that will save you money in the process.

FEATURES AND BENEFITS

- Flexi-strip available in low (30LED/m), standard (60LED/m) and high (120LED/m) density format using high efficiency SMD LED (5050 or 2835)
Provides high brightness and uniform light distribution
- Low power consumption (4.8W/m, 7.2W/m, 9.6W/m, 12W/m, 14.4W/m)
Helps to save energy - tremendous lighting effects can be achieved at very low running costs
- Cool running with no ultra violet or infra-red in the light beam
Will not burn, damage or fade leaves, flowers or other sensitive displays
- 3 years ROBUS warranty / 30,000 hours rated life
Provides over 10 years' service at 5 hours per day
- Range of control components available (drivers / controllers / amplifiers)
Bespoke designs & controls can be achieved
- Additional connector packs and IP rated boxes with 4 terminal connector block (for waterproof LED strip)
Can be used where strip is cut and joined into multiple short lengths / Suitable for control component or wiring joins where conditions are not dry
- Aluminum extrusions accessories
Help to achieve continuous light line, gives nice aesthetics and helps to protect LED strip



CUT TO LENGTH



FLEXIBLE



LOW PROFILE



COLOUR OPTIONS



ADDED PROTECTION



DIMMABLE



**3M TAPE / PEEL
& STICK**



**ROBUS CONNECT
AVAILABLE**



VEGAS IP20 LED FLEXI-STRIP

IP20 12V NON-WATERPROOF FLEXI-STRIP	14
4.8W/M SINGLE COLOUR, STANDARD DENSITY	14
7.2W/M RGB COLOUR CHANGING, LOW DENSITY	16
IP20 24V NON-WATERPROOF FLEXI-STRIP	18
9.6W/M SINGLE COLOUR, HIGH DENSITY	18
14.4W/M RGB COLOUR CHANGING, STANDARD DENSITY	20

VEGAS LED IP20 12V NON-WATERPROOF FLEXI-STRIP SINGLE COLOUR



4.8W/M, 12V, STANDARD DENSITY, 60LED/M, SMD2835



- VEGAS single colour SMD2835 LED flexi-strip with 3M™ self-adhesive tape
- Low power consumption of 4.8W per meter
- Cutting points every 3 LEDs / 5cm
- Requires 12V LED driver (sold separately)
- Voltage drop of 2.86V per 10m and maximum continuous run of 10m
- For runs over 10m individual lengths should be connected in parallel
- Available in warm white and neutral white
- Easy clip connector packs available as accessories

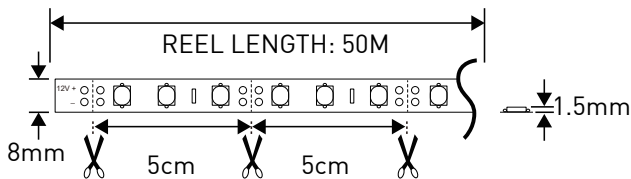

CODE	POWER	VOLTAGE	LUMENS	BEAM ANGLE	COLOUR	CRI	IP	REEL	LIFETIME
RVA48302050	4.8W/m	12V	500LM/m	120°	3000K	80	20	50m	30,000hrs
RVA48402050	4.8W/m	12V	510LM/m	120°	4000K	80	20	50m	30,000hrs

IP20 NON-DIMMABLE DRIVERS COMPATIBILITY LIST

CODE	DESCRIPTION	M PER DRIVER
RVA3012-PSU	VEGAS 30W, 12V, IP20 constant voltage driver, non-dimmable	1m – 6m
RVA6012-PSU	VEGAS 60W, 12V, IP20 constant voltage driver, non-dimmable	7m – 12m
RVA10012-PSU	VEGAS 100W, 12V, IP20 constant voltage driver, non dimmable	13m – 20m
RVA18012-PSU	VEGAS 180W, 12V, IP20 constant voltage driver, non dimmable	21m – 37m

IP20 DIMMABLE DRIVERS COMPATIBILITY LIST

CODE	DESCRIPTION	M PER DRIVER
RVA3012DU-PSU	VEGAS 30W, 12V, IP20 driver, triac dimmable	1m – 6m
RVA5012DU-PSU	VEGAS 50W, 12V, IP20 driver, triac dimmable	7m – 10m
RVA7512DU-PSU	VEGAS 75W, 12V, IP20 driver, triac dimmable	11m – 15m

LED FLEXI-STRIP CLIP CONNECTORS

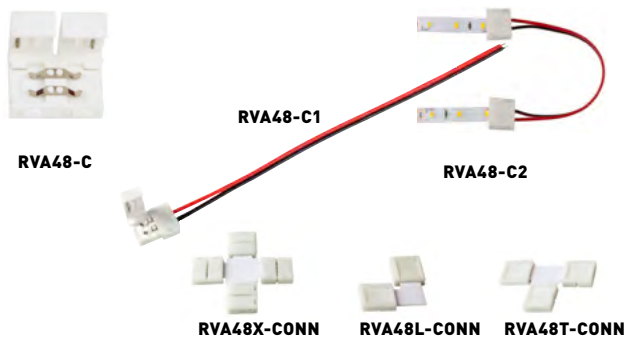

- RVA48-C** - STRIP-TO-STRIP CONNECTOR WITHOUT WIRES
- RVA48-C1** - STRIP-TO-DRIVER CONNECTOR WITH 150MM WIRE
- RVA48-C2** - STRIP-TO-STRIP CONNECTOR WITH 150MM WIRE
- RVA48X-CONN** - "X" EASY CLIP CONNECTOR
- RVA48T-CONN** - "T" EASY CLIP CONNECTOR
- RVA48L-CONN** - "L" EASY CLIP CONNECTOR

IP20 DRIVERS PAGE 52

AMPLIFIERS & CONTROLLERS PAGE 46

EXTRUSIONS PAGE 60

VEGAS LED IP20 12V NON-WATERPROOF FLEXI-STRIP RGB COLOUR CHANGING

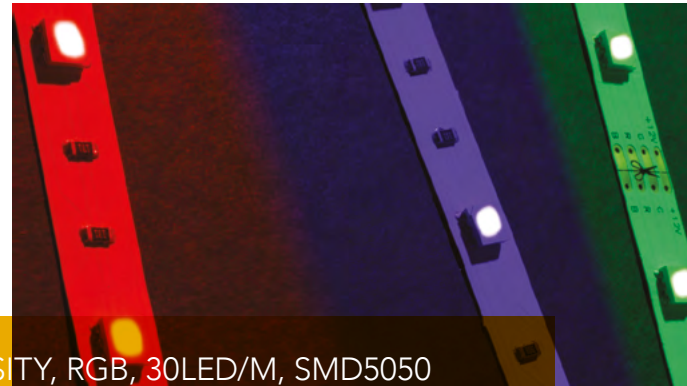

7.2W, 12V, LOW DENSITY, RGB, 30LED/M, SMD5050

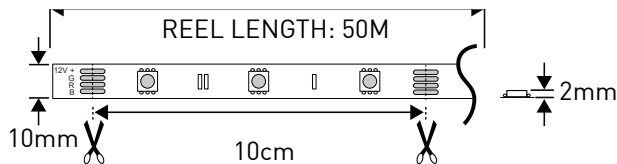

- VEGAS RGB (Red, Green, Blue) colour changing SMD5050 LED flexi-strip with 3M™ self-adhesive tape
- Power consumption of 7.2W per meter
- Cutting points every 3 LEDs / 10cm
- Requires 12V LED driver (sold separately)
- Voltage drop of 3.5V per 10m and maximum continuous run of 5m
- For runs over 5m individual lengths should be connected in parallel
- Easy clip connector packs available as accessories
- Requires RGB Controller (sold separately)



RGB

CODE	POWER	VOLTAGE	LUMENS	BEAM ANGLE	COLOUR	CRI	IP	REEL	LIFETIME
RVA72RGB2050	7.2/m	12V	-	120°	RGB	-	20	50m	30,000hrs

IP20 NON-DIMMABLE DRIVERS COMPATIBILITY LIST

CODE	DESCRIPTION	M PER DRIVER
RVA3012-PSU	VEGAS 30W, 12V, IP20 constant voltage driver, non-dimmable	1m – 4m
RVA6012-PSU	VEGAS 60W, 12V, IP20 constant voltage driver, non-dimmable	5m – 8m
RVA10012-PSU	VEGAS 100W, 12V, IP20 constant voltage driver, non-dimmable	9m – 13m
RVA18012-PSU	VEGAS 180W, 12V, IP20 constant voltage driver, non-dimmable	14m – 25m

LED FLEXI-STRIP CLIP CONNECTORS

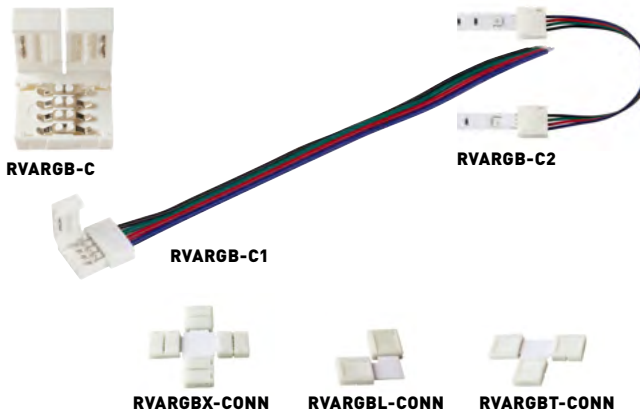

- RVARGB-C** - STRIP-TO-STRIP CONNECTOR WITHOUT WIRES
- RVARGB-C1** - STRIP-TO-DRIVER CONNECTOR WITH 150MM WIRE
- RVARGB-C2** - STRIP-TO-STRIP CONNECTOR WITH 150MM WIRE
- RVARGBX-CONN** - "X" EASY CLIP CONNECTOR
- RVARGBT-CONN** - "T" EASY CLIP CONNECTOR
- RVARGBL-CONN** - "L" EASY CLIP CONNECTOR

IP20 DRIVERS PAGE 52

RGB AMPLIFIERS & CONTROLLERS PAGE 46

EXTRUSIONS PAGE 60

ROBUS VEGAS LED FLEXI-STRIP



VEGAS LED IP20 24V NON-WATERPROOF FLEXI-STRIP SINGLE COLOUR



9.6W/M, 24V, HIGH DENSITY, 120LED/M, SMD2835



- VEGAS single colour SMD2835 LED flexi-strip with 3M™ self-adhesive tape
- Low power consumption of 9.6W per meter
- Cutting points every 6 LEDs / 5cm
- Requires 24V LED driver (sold separately)
- Voltage drop of 4V per 10m and maximum continuous run of 10m
- For runs over 10m individual lengths should be connected in parallel
- Available in warm white and neutral white
- Easy clip connector packs available as accessories

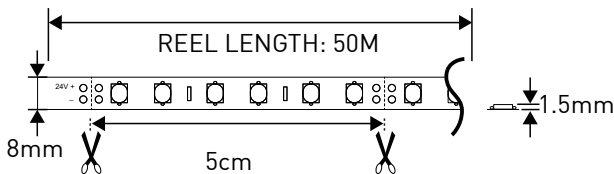

CODE	POWER	VOLTAGE	LUMENS	BEAM ANGLE	COLOUR	CRI	IP	REEL	LIFETIME
RVA96302050	9.6W/m	24V	1070LM/m	120°	3000K	80	20	50m	30,000hrs
RVA96402050	9.6W/m	24V	1075LM/m	120°	4000K	80	20	50m	30,000hrs



IP20 NON-DIMMABLE DRIVERS COMPATIBILITY LIST

CODE	DESCRIPTION	M PER DRIVER
RVA3024-PSU	VEGAS 30W, 24V, IP20 constant voltage driver, non-dimmable	1m – 3m
RVA6024-PSU	VEGAS 60W, 24V, IP20 constant voltage driver, non-dimmable	4m – 6m
RVA10024-PSU	VEGAS 100W, 24V, IP20 constant voltage driver, non-dimmable	7m – 10m
RVA15024-PSU	VEGAS 150W, 24V, IP20 constant voltage driver, non dimmable	11m – 15m
RVA25024-PSU	VEGAS 250W, 24V, IP20 constant voltage driver, non dimmable	16m – 26m
RVA32024-PSU	VEGAS 320W, 24V, IP20 constant voltage driver, non dimmable	27m – 33m

IP20 DIMMABLE DRIVERS COMPATIBILITY LIST

CODE	DESCRIPTION	M PER DRIVER
RVA3024DU-PSU	VEGAS 30W, 24V, IP20 driver, triac dimmable	1m – 3m
RVA5024DU-PSU	VEGAS 50W, 24V, IP20 driver, triac dimmable	4m – 5m
RVA7524DU-PSU	VEGAS 75W, 24V, IP20 driver, triac dimmable	6m – 7m

FLEXI-STRIP CLIP CONNECTORS



- RVA96-C** - STRIP-TO-STRIP CONNECTOR WITHOUT WIRES
- RVA96-C1** - STRIP-TO-DRIVER CONNECTOR WITH 150MM WIRE
- RVA96-C2** -STRIP-TO-STRIP CONNECTOR WITH 150MM WIRE

IP20 DRIVERS PAGE 52

AMPLIFIERS & CONTROLLERS PAGE 46

EXTRUSIONS PAGE 60

ROBUS VEGAS LED FLEXI-STRIP



VEGAS LED IP20 24V NON-WATERPROOF FLEXI-STRIP RGB COLOUR CHANGING

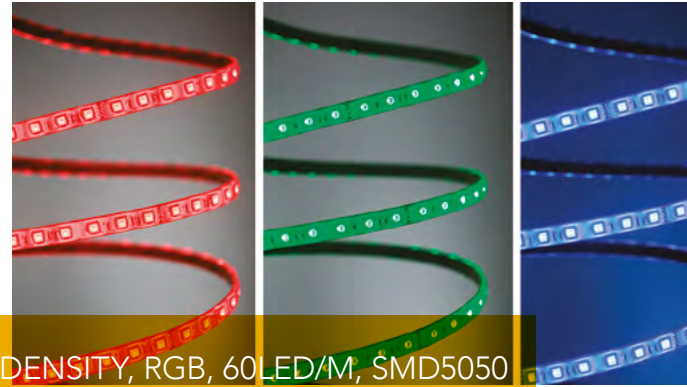

14.4W/M, 24V, STANDARD DENSITY, RGB, 60LED/M, SMD5050

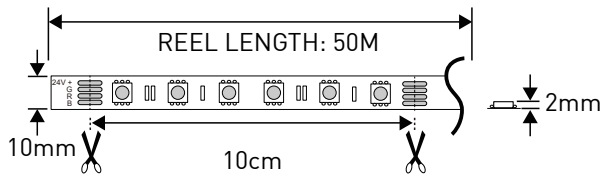

- VEGAS RGB colour changing SMD5050 LED flexi-strip with 3M™ self-adhesive tape
- Power consumption of 14.4W per meter
- Cutting points every 6 LEDs /10cm
- Requires 24V LED driver (sold separately)
- Voltage drop of 3.5V per 10m and maximum continuous run of 5m
- For runs over 5m individual lengths should be connected in parallel
- Easy clip connector packs available as accessories
- Requires RGB Controller (sold separately)



CODE	POWER	VOLTAGE	LUMENS	BEAM ANGLE	COLOUR	CRI	IP	REEL	LIFETIME
RVA14RGB2050	14.4W/m	24V	-	120°	RGB	-	20	50m	30,000hrs

IP20 NON-DIMMABLE DRIVERS COMPATIBILITY LIST

CODE	DESCRIPTION	M PER DRIVER
RVA3024-PSU	VEGAS 30W, 24V, IP20 constant voltage driver, non-dimmable	1m – 2m
RVA6024-PSU	VEGAS 60W, 24V, IP20 constant voltage driver, non-dimmable	3m – 4m
RVA10024-PSU	VEGAS 100W, 24V, IP20 constant voltage driver, non-dimmable	5m – 6m
RVA15024-PSU	VEGAS 150W, 24V, IP20 constant voltage driver, non-dimmable	7m – 10m
RVA25024-PSU	VEGAS 250W, 24V, IP20 constant voltage driver, non-dimmable	11m-17m
RVA32024-PSU	VEGAS 320W, 24V, IP20 constant voltage driver, non-dimmable	18m - 22m

LED FLEXI-STRIP CLIP CONNECTORS



RVARGB-C

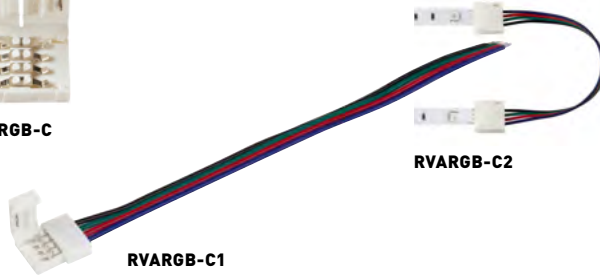

RVARGB-C1

RVARGB-C2



RVARGBX-CONN



RVARGBL-CONN



RVARGBT-CONN

RVARGB-C STRIP-TO-STRIP CONNECTOR WITHOUT WIRES

RVARGB-C1 STRIP-TO-DRIVER CONNECTOR WITH 150MM WIRE

RVARGB-C2 STRIP-TO-STRIP CONNECTOR WITH 150MM WIRE

RVARGBX-CONN - "X" EASY CLIP CONNECTOR

RVARGBT-CONN - "T" EASY CLIP CONNECTOR

RVARGBL-CONN - "L" EASY CLIP CONNECTOR

IP20 DRIVERS

PAGE 52

RGB AMPLIFIERS & CONTROLLERS

PAGE 46

EXTRUSIONS

PAGE 60

ROBUS VEGAS LED FLEXI-STRIP





Enable Ireland,
Cork, Ireland



HOW TO CONNECT 12V SINGLE COLOUR VEGAS LED FLEXI-STRIP

EXAMPLE INSTALLATION: SINGLE COLOUR CONTROLLER - 10M VEGAS IP20 4.8W/M FLEXI-STRIP

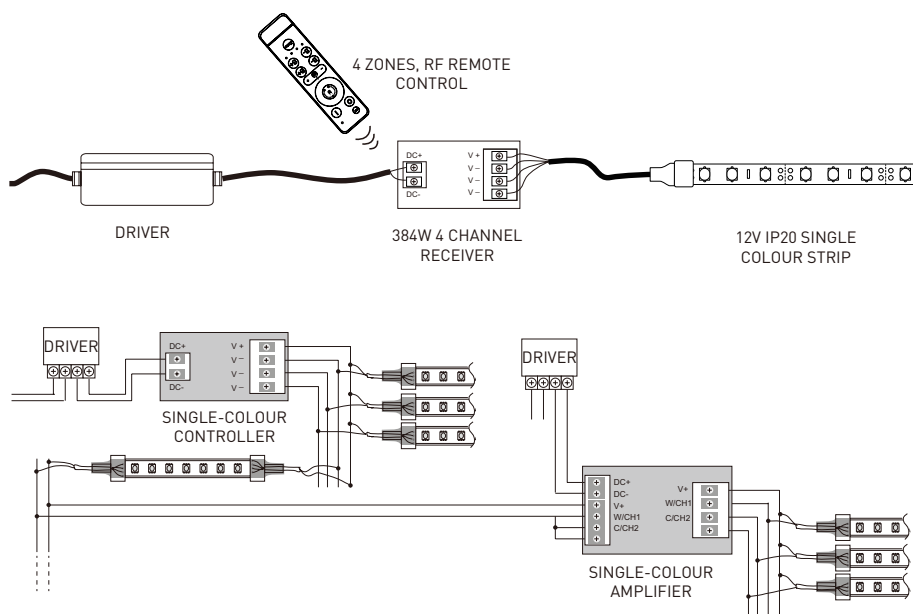

	CODE	2M	5M	10M	11-20M	21-30M	31-40M	41-50M
LED STRIP	RVA48X02050	1	1	1	2	3	4	5
VEGAS 4 Zones, RF remote control	RVA4Z-RC	1	1	1	1	1	1	1
VEGAS 384W 4 Channel receiver	RVA4CH-REC	1	1	1	1	1	1	1
SINGLE COLOUR AMPLIFIER	RVACCT1-AMP	0	0	0	1	2	3	4
12V CV NON-DIM LED DRIVER 30W	RVA3012-PSU	1	1	0	0	0	0	0
12V CV NON-DIM LED DRIVER 60W	RVA6012-PSU	0	0	1	2	3	4	5

Note: Controller and amplifier only required for white flexi-strip that is to be dimmed
WIFI version available

HOW TO CONNECT 12V RGB VEGAS LED FLEXI-STRIP

EXAMPLE INSTALLATION: RGB CONTROLLER - 5M VEGAS RGB IP20W 7.2W 12V STRIP

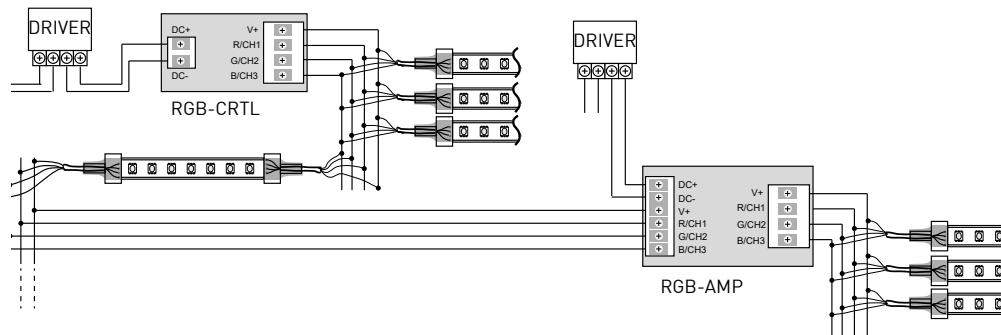
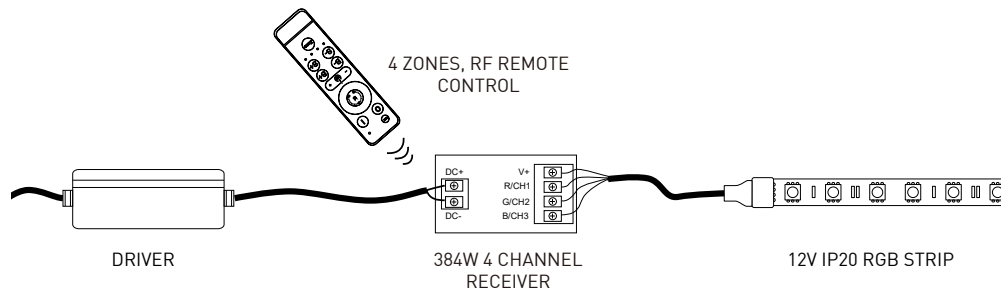

	CODE	2M	5M	10M	11-15M	16-20M	21-25M	26-30M
LED STRIP	RVA72RGB2050	1	1	2	3	4	5	6
VEGAS 4 Zones, RF remote control	RVA4Z-RC	1	1	1	1	1	1	1
VEGAS 384W 4 Channel receiver	RVA4CH-REC	1	1	1	1	1	1	1
RGB AMPLIFIER	RVARGB-AMP	0	0	1	2	3	4	5
12V CV NON-DIM LED DRIVER 30W	RVA3012-PSU	1	0	0	0	0	0	0
12V CV NON-DIM LED DRIVER 60W	RVA6012-PSU	0	1	2	3	4	5	6

Note: The signal to the amplifier can come from any part of the system where the RGB and common are available
WIFI version available

HOW TO CONNECT 24V SINGLE COLOUR VEGAS LED FLEXI-STRIP

EXAMPLE INTALLATION SINGLE COLOUR CONTROLLER - 10M VEGAS IP20 9.6W/M STRIP

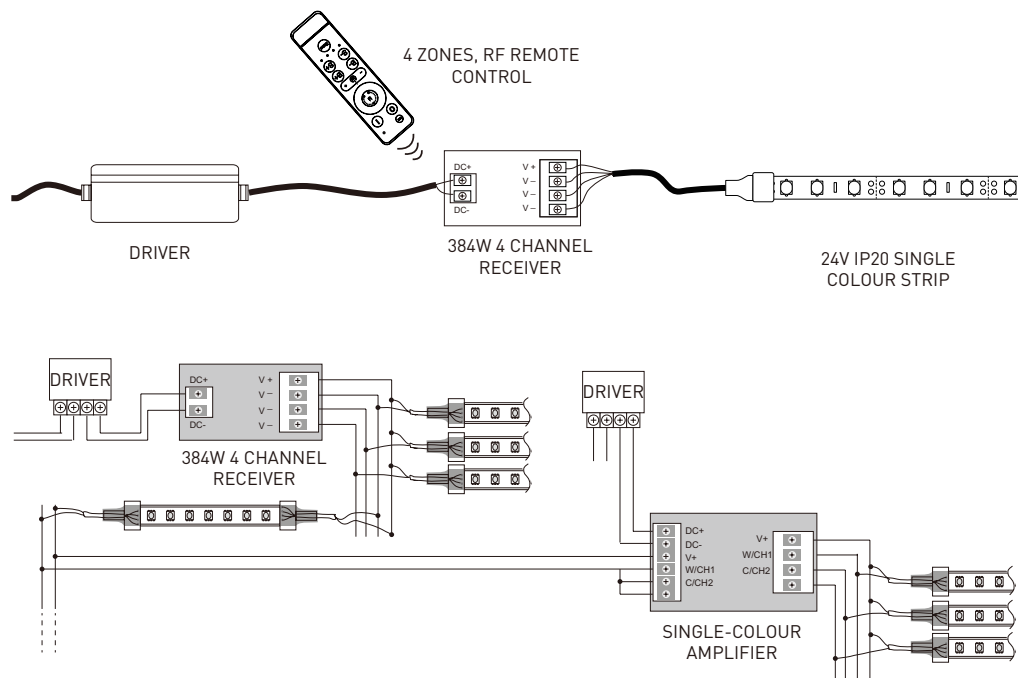

	CODE	2M	5M	10M	11-20M	21-30M	31-40M	41-50M
LED STRIP	RVA96X02050	1	1	1	2	3	4	5
VEGAS 4 Zones, RF remote control	RVA4Z-RC	1	1	1	1	1	1	1
VEGAS 384W 4 Channel receiver	RVA4CH-REC	1	1	1	1	1	1	2
SINGLE COLOUR AMPLIFIER	RVACCT1-AMP	0	0	0	1	2	3	4
24V CV NON-DIM LED DRIVER 30W	RVA3024-PSU	1	0	0	0	0	0	0
24V CV NON-DIM LED DRIVER 60W	RVA6024-PSU	0	1	0	0	0	0	0
24V CV NON-DIM LED DRIVER 100W	RVA10024-PSU	0	0	1	2	3	4	5

Note: Controller and amplifier only required for white flexi-strip that is to be dimmed
WIFI version available

HOW TO CONNECT 24V RGB+ WHITE VEGAS LED FLEXI-STRIP

EXAMPLE INTALLATION RGB CONTROLLER - 5M VEGAS RGB IP20 14.4W/M STRIP

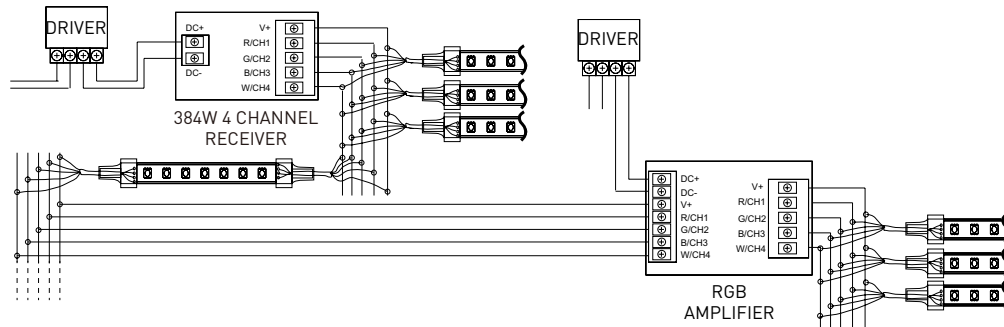
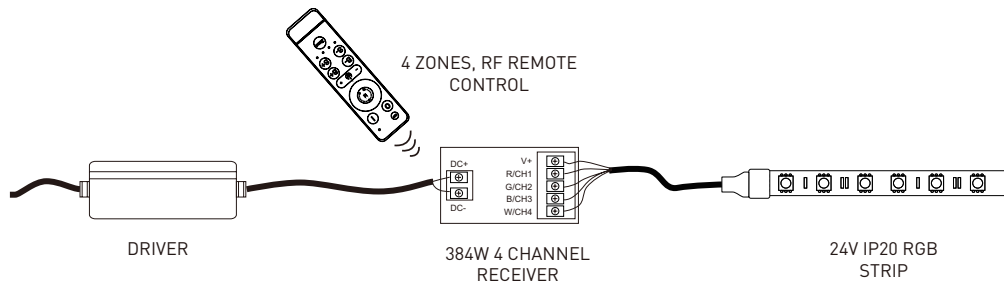

	CODE	2M	5M	10M	11-15M	16-20M	21-25M	26-30M
LED STRIP	RVA14RGBW2050-X0	1	1	2	3	4	5	6
VEGAS 4 Zones, RF remote control	RVA4Z-RC	1	1	1	1	1	1	1
VEGAS 384W 4 Channel receiver	RVA4CH-REC	1	1	1	1	1	1	2
RGB / RGBW AMPLIFIER	RVARGB-AMP	0	0	1	2	3	4	5
24V CV NON-DIM LED DRIVER 30W	RVA3024-PSU	1	0	0	0	0	0	0
24V CV NON-DIM LED DRIVER 100W	RVA10024-PSU	0	1	2	3	4	5	6

Note: The signal to the amplifier can come from any part of the system where the RGBW and common are available
WIFI version available



VEGAS IP67 LED FLEXI-STRIP

IP67 12V WATERPROOF FLEXI-STRIP	30
4.8W/M SINGLE COLOUR, STANDARD DENSITY	30
7.2W/M RGB COLOUR CHANGING, LOW DENSITY	32
IP67 24V WATERPROOF FLEXI-STRIP	34
9.6W/M SINGLE COLOUR, HIGH DENSITY	34
14.4W/M RGB COLOUR CHANGING, STANDARD DENSITY	36
12W/M RGBW COLOUR CHANGING, STANDARD DENSITY	38

VEGAS LED IP67 12V WATERPROOF FLEXI-STRIP SINGLE COLOUR



4.8W/M, 12V, STANDARD DENSITY, 60LED/M, SMD2835

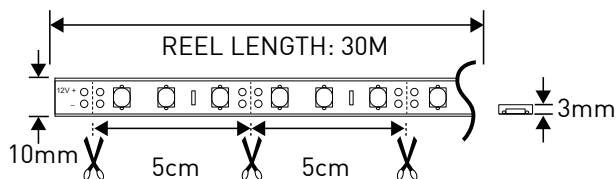

- VEGAS single colour SMD2835 LED flexi-strip with 3M™ self-adhesive tape
- Low power consumption of 4.8W per meter
- Cutting points every 3 LEDs / 5cm
- Requires 12V LED driver
- Voltage drop of 2.86V per 10m and maximum continuous run of 10m
- For runs over 10m individual lengths should be connected in parallel
- Available in warm white and neutral white
- Easy clip connector packs available as accessories



CODE	POWER	VOLTAGE	LUMENS	BEAM ANGLE	COLOUR	CRI	IP	REEL	LIFETIME
RVA48306730	4.8W/m	12V	480LM/m	120°	3000K	80	67	30m	30,000hrs
RVA48406730	4.8W/m	12V	515LM/m	120°	4000K	80	67	30m	30,000hrs

IP67 NON-DIMMABLE DRIVERS COMPATIBILITY LIST

CODE	DESCRIPTION	M PER DRIVER
RVA10012IP67-PSU	VEGAS 100W, 12V, IP67 constant voltage driver, non-dimmable	1m – 20m
RVA20012IP67-PSU	VEGAS 200W, 12V, IP67 constant voltage driver, non-dimmable	21m – 41m

LED FLEXI-STRIP CLIP CONNECTORS

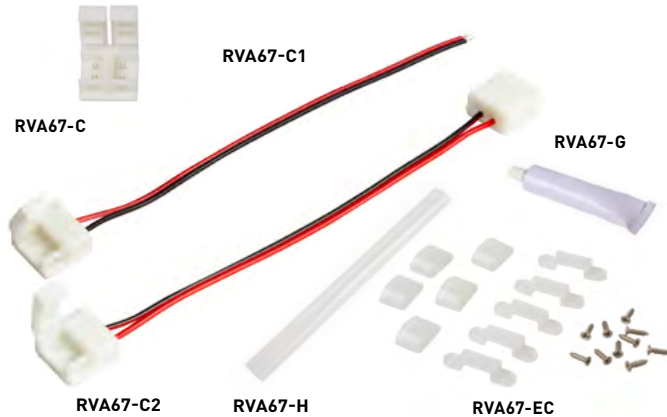

- RVA67-C** - STRIP TO STRIP CONNECTOR WITHOUT WIRES
- RVA67-C1** - STRIP TO DRIVER CONNECTOR, WITH 150 MM WIRE
- RVA67-C2** - STRIP TO STRIP CONNECTOR WITH 150MM WIRE
- RVA67-H** - HEAT SHRINK
- RVA67-G** - GLUE
- RVA67-EC** - END CAPS AND CLIPS



RVBIP2
IP RATED BOX, LARGE



RVBIP1
IP RATED BOX, SMALL

IP67 DRIVERS PAGE 54

AMPLIFIERS & CONTROLLERS PAGE 46

EXTRUSIONS PAGE 60

ROBUS VEGAS LED FLEXI-STRIP



VEGAS LED IP67 12V WATERPROOF FLEXI-STRIP RGB COLOUR CHANGING

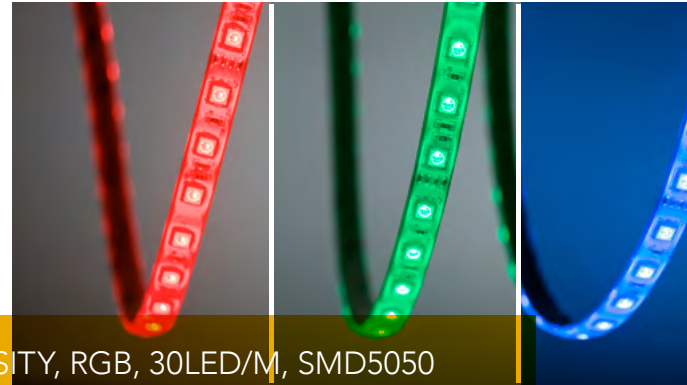

7.2W, 12V, LOW DENSITY, RGB, 30LED/M, SMD5050

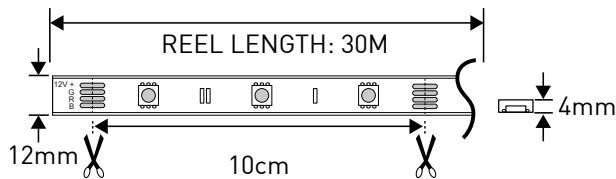
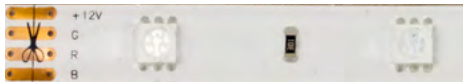

- VEGAS RGB colour changing SMD5050 LED flexi-strip with 3M™ self-adhesive tape
- Power consumption of 7.2W per meter
- Cutting points every 3 LEDs / every 10cm
- Requires 12V (sold separately)
- Voltage drop of 3.5V per 10m and maximum continuous run of 5m
- For runs over 5m individual lengths should be connected in parallel
- Easy clip connector packs available as accessories
- Requires RGB Controller (sold separately)



CODE	POWER	VOLTAGE	LUMENS	BEAM ANGLE	COLOUR	CRI	IP	REEL	LIFETIME
RVA72RGB6730	7.2/m	12V	-	120°	RGB	-	67	30m	30,000hrs

IP67 NON-DIMMABLE DRIVERS COMPATIBILITY LIST

CODE	DESCRIPTION	M PER DRIVER
RVA10012IP67-PSU	VEGAS 100W, 12V, IP67 constant voltage driver, non-dimmable	1m – 13m
RVA20012IP67-PSU	VEGAS 200W, 12V, IP20 constant voltage driver, non-dimmable	14m – 27m

LED FLEXI-STRIP CLIP CONNECTORS



RVA67RGB-C - STRIP TO STRIP CONNECTOR WITHOUT WIRES
RVA67RGB-C1 - STRIP TO DRIVER CONNECTOR, WITH 150 MM WIRE
RVA67RGB-C2 - STRIP TO STRIP CONNECTOR WITH 150MM WIRE
RVA67-H - HEAT SHRINK
RVA67-G - GLUE
RVA67RGBW-EC - END CAPS AND CLIPS



RVBIP2
IP RATED BOX, LARGE



RVBIP1
IP RATED BOX, SMALL

IP67 DRIVERS PAGE 54

AMPLIFIERS & CONTROLLERS PAGE 46

EXTRUSIONS PAGE 60

VEGAS LED IP67 24V WATERPROOF FLEXI-STRIP SINGLE COLOUR



9.6W/M, 24V, HIGH DENSITY, 120LED/M, SMD2835

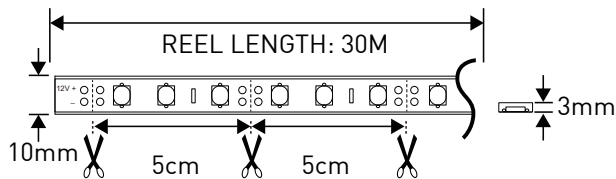

- VEGAS single colour SMD2835 LED flexi-strip with 3M™ self-adhesive tape
- Low power consumption of 9.6W per meter
- Cutting points every 6 LEDs / 5cm
- Requires 24V LED driver (sold separately)
- Voltage drop of 4V per 10m and maximum continuous run of 10m
- For runs over 10m individual lengths should be connected in parallel
- Available in warm white and neutral white
- Easy clip connector packs available as accessories



CODE	POWER	VOLTAGE	LUMENS	BEAM ANGLE	COLOUR	CRI	IP	REEL	LIFETIME
RVA96306730	9.6W/m	24V	990LM/m	120°	3000K	80	67	30m	30,000hrs
RVA96406730	9.6W/m	24V	995LM/m	120°	4000K	80	67	30m	30,000hrs

IP67 NON-DIMMABLE DRIVERS COMPATIBILITY LIST

CODE	DESCRIPTION	M PER DRIVER
RVA6024IP67-PSU	VEGAS 60W, 24V, IP67 constant voltage driver, non-dimmable	1m – 6m
RVA10024IP67-PSU	VEGAS 100W, 24V, IP67 constant voltage driver, non-dimmable	7m – 10m
RVA20024IP67-PSU	VEGAS 200W, 24V, IP67 constant voltage driver, non-dimmable	11m – 20m
RVA32024IP67-PSU	VEGAS 320W, 24V, IP67 constant voltage driver, non-dimmable	21m – 33m

LED FLEXI-STRIP CLIP CONNECTORS

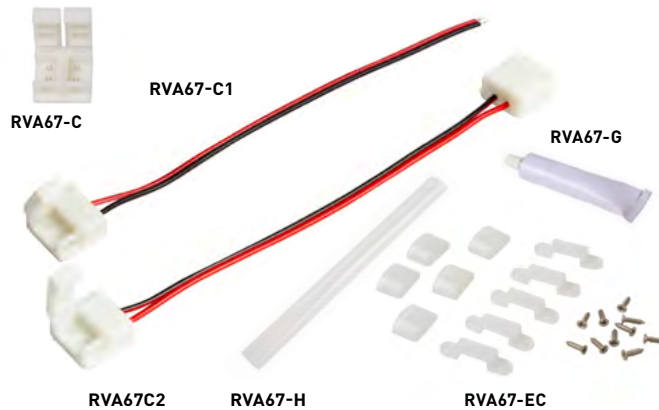

- RVA67-C** - STRIP TO STRIP CONNECTOR WITHOUT WIRES
RVA67-C1 - STRIP TO DRIVER CONNECTOR, WITH 150 MM WIRE
RVA67-C2 - STRIP TO STRIP CONNECTOR WITH 150MM WIRE
RVA67-H - HEAT SHRINK
RVA67-G - GLUE
RVA67-EC - END CAPS AND CLIPS



RVBIP2
IP RATED BOX, LARGE



RVBIP1
IP RATED BOX, SMALL

IP67 DRIVERS PAGE 54

AMPLIFIERS & CONTROLLERS PAGE 46

EXTRUSIONS PAGE 60

ROBUS VEGAS LED FLEXI-STRIP



VEGAS LED IP67 24V WATERPROOF FLEXI-STRIP RGB COLOUR CHANGING

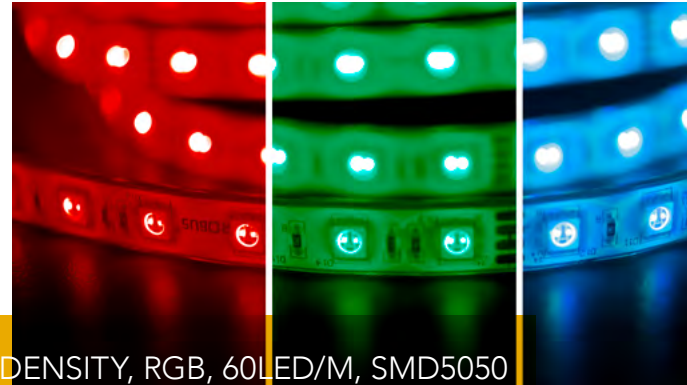

14.4W/M, 24V, STANDARD DENSITY, RGB, 60LED/M, SMD5050

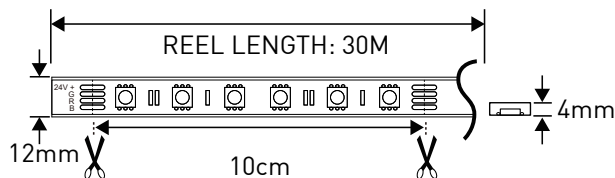

- VEGAS RGB colour changing SMD5050 LED flexi-strip with 3M™ self-adhesive tape
- Power consumption of 14.4W per meter
- Cutting points every 6 LEDs / 10cm
- Requires 24V LED driver (sold separately)
- Voltage drop of 3.5V per 10m and maximum continuous run of 5m
- For runs over 5m individual lengths should be connected in parallel
- Easy clip connector packs available as accessories
- Requires RGB Controller (sold separately)



CODE	POWER	VOLTAGE	LUMENS	BEAM ANGLE	COLOUR	CRI	IP	REEL	LIFETIME
RVA14RGB6730	14.4W/m	24V	-	120°	RGB	-	67	30m	30,000hrs

IP67 NON-DIMMABLE DRIVERS COMPATIBILITY LIST

CODE	DESCRIPTION	M PER DRIVER
RVA6024IP67-PSU	VEGAS 60W, 24V, IP67 constant voltage driver, non-dimmable	1m – 4m
RVA10024IP67-PSU	VEGAS 100W, 24V, IP67 constant voltage driver, non-dimmable	5m – 6m
RVA20024IP67-PSU	VEGAS 200W, 24V, IP67 constant voltage driver, non-dimmable	7m – 13m
RVA32024IP67-PSU	VEGAS 320W, 24V, IP67 constant voltage driver, non-dimmable	14m – 22m

LED FLEXI-STRIP CLIP CONNECTORS



RVA67RGB-C

RVA67RGB-C2

RVA67-G

RVA67RGB-C1

RVA67-H

RVA67RGBW-EC

- RVA67RGB-C** - STRIP TO STRIP CONNECTOR WITHOUT WIRES
- RVA67RGB-C1** - STRIP TO DRIVER CONNECTOR, WITH 150 MM WIRE
- RVA67RGB-C2** - STRIP TO STRIP CONNECTOR WITH 150MM WIRE
- RVA67-H** - HEAT SHRINK
- RVA67-G** - GLUE
- RVA67RGBW-EC** - END CAPS AND CLIPS



RVBIP2
IP RATED BOX, LARGE



RVBIP1
IP RATED BOX, SMALL

IP67 DRIVERS PAGE 54

AMPLIFIERS & CONTROLLERS PAGE 46

EXTRUSIONS PAGE 60



VEGAS LED IP67 24V WATERPROOF FLEXI-STRIP RGBW COLOUR CHANGING



12W/M, 24V, STANDARD DENSITY, RGBW, 60LED/M, SMD5050

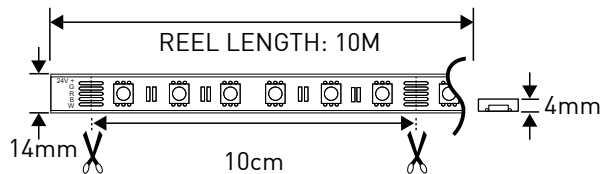

- VEGAS RGBW colour changing SMD5050 LED flexi-strip with 3M™ self-adhesive tape
- Power consumption of 12W per meter
- Cutting points every 6 LEDs / 10 cm
- Requires 24V LED driver (sold separately)
- Voltage drop of 4.5V per 10m and maximum continuous run of 5m
- For runs over 5m individual lengths should be connected in parallel
- Easy clip connector pack available as accessories
- Requires RGBW Controller (sold separately)



CODE	POWER	VOLTAGE	BEAM ANGLE	COLOUR	CRI	IP	REEL	LIFETIME
RVA12RGBW6710-30	12W/m	24V	120°	RGB + 3000K	80	67	10m	30,000hrs
RVA12RGBW6710-40	12W/m	24V	120°	RGB + 4000K	80	67	10m	30,000hrs

IP67 NON-DIMMABLE DRIVERS COMPATIBILITY LIST

CODE	DESCRIPTION	M PER DRIVER
RVA6024IP67-PSU	VEGAS 60W, 24V, IP67 constant voltage driver, non dimmable	1m-5m
RVA10024IP67-PSU	VEGAS 100W, 24V, IP67 constant voltage driver, non dimmable	6m-8m
RVA20024IP67-PSU	VEGAS 200W, 24V, IP67 constant voltage driver, non dimmable	9m-16m
RVA32024IP67-PSU	VEGAS 320W, 24V, IP67 constant voltage driver, non dimmable	17m-26m

LED FLEXI-STRIP CLIP CONNECTORS

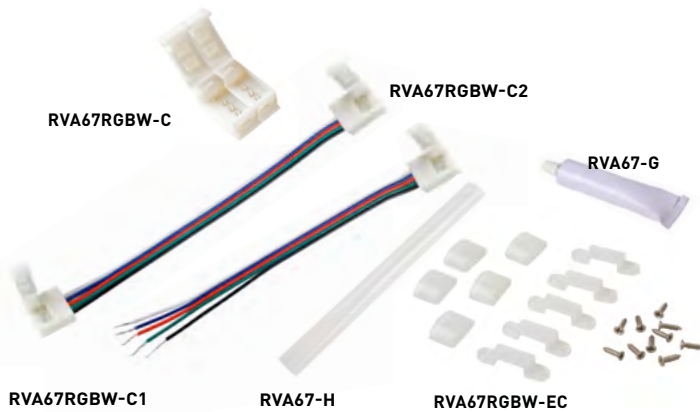

- RVA67RGBW-C** - STRIP TO STRIP CONNECTOR WITHOUT WIRES
- RVA67RGBW-C1** - STRIP TO DRIVER CONNECTOR, WITH 150 MM WIRE
- RVA67RGBW-C2** - STRIP TO STRIP CONNECTOR WITH 150MM WIRE
- RVA67-H** - HEAT SHRINK
- RVA67-G** - GLUE
- RVA67RGBW-EC** - END CAPS AND CLIPS



RVBIP2
IP RATED BOX, LARGE



RVBIP1
IP RATED BOX, SMALL

IP67 DRIVERS PAGE 54

AMPLIFIERS & CONTROLLERS PAGE 46

EXTRUSIONS PAGE 60

ROBUS VEGAS LED FLEXI-STRIP



HOW TO CONNECT IP67 FLEXI-STRIP WITH CONTROLLER AND POWER SUPPLY

EXAMPLE INTALLATION SINGLE COLOUR CONTROLLER - 10M VEGAS IP67 9.6W/M STRIP

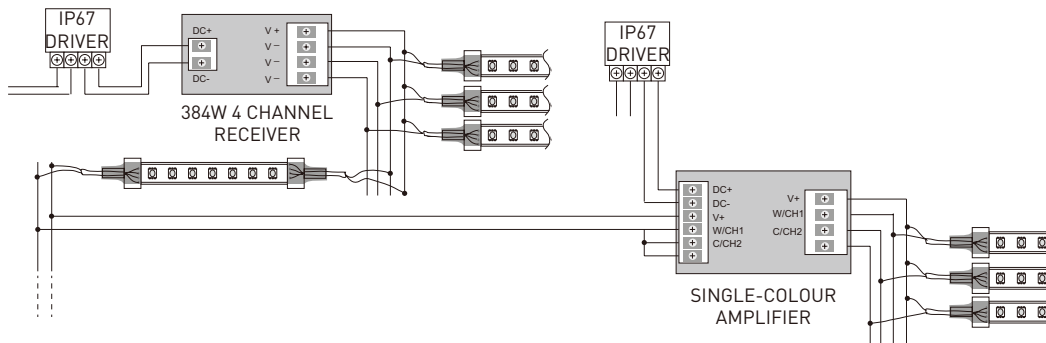
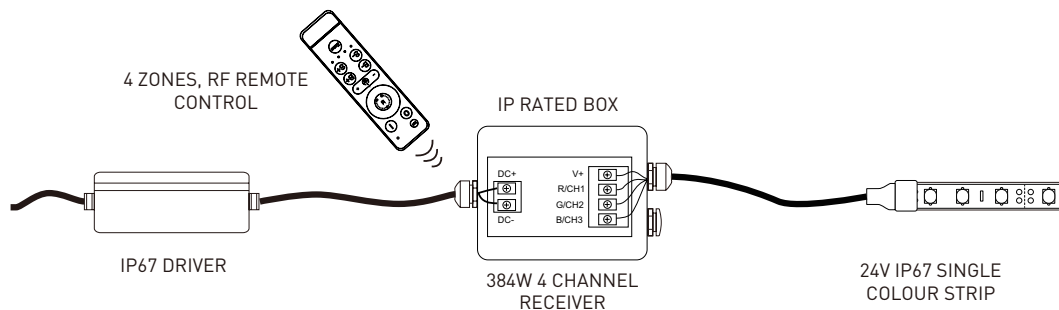

	CODE	2M	5M	10M	11-20M	21-30M	31-40M	41-50M
LED STRIP	RVA96X06730	1	1	1	2	3	4	5
VEGAS 4 Zones, RF remote control	RVA4Z-RC	1	1	1	1	1	1	1
VEGAS 384W 4 Channel receiver	RVA4CH-REC	1	1	1	1	1	1	2
SINGLE COLOUR AMPLIFIER	RVACCT1-AMP	0	0	0	1	2	3	4
IP RATED BOX	RVBIP2	1	1	1	2	3	4	5

Note: Controller and amplifier only required for white flexi-strip that is to be dimmed
WIFI version available

EXAMPLE INTALLATION RGBW CONTROLLER - 5M VEGAS RGBW 12W/M STRIP IP67

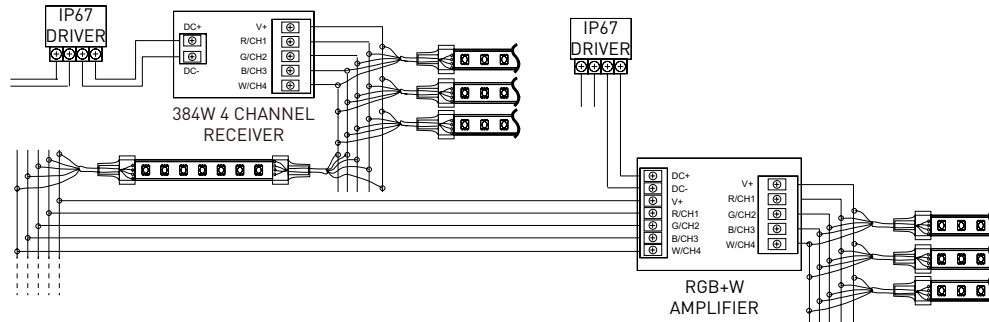
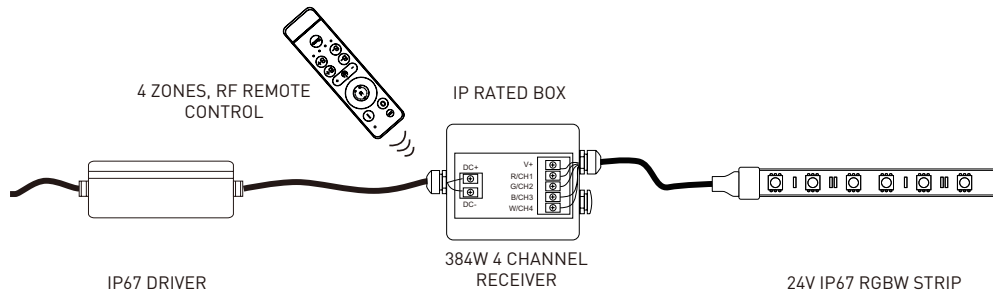

	CODE	2M	5M	10M	11-15M	16-20M	21-25M	26-30M
LED STRIP	RVA12RGBW6730-x0	1	1	2	3	4	5	6
VEGAS 4 Zones, RF remote control	RVA4Z-RC	1	1	1	1	1	1	1
VEGAS 384W 4 Channel receiver	RVA4CH-REC	1	1	1	1	1	1	2
RGBW AMPLIFIER	RVARGBW-AMP	0	0	1	2	3	4	5
24V CV NON-DIM LED DRIVER 100W IP67	RVA10024IP67-PSU	0	1	2	3	4	5	6
IP Rated Box	RVBIP2	1	1	2	3	4	5	6

Note: The signal to the amplifier can come from any part of the system where the RGBW and common are available
WIFI version available

HOW TO CUT AND CONNECT LED WATERPROOF FLEXI-STRIP USING IP67 CONNECTOR PACK AND MAINTAINING IP RATING

STEP 1:

Ensure mains supply is switched off before commencing work.

STEP 2:

When cutting, ensure that the cut is made at the scissor mark.

STEP 3:

When cut, to make the final cut end weather proof, use the supplied end-cap & glue. Apply glue to the end-cap and push onto the end of the strip. Ensure it is sealed.*

STEP 4:

Peel back 5mm of 3M tape. Open the connector, keep the LEDs pointing upwards, align the teeth with the copper conductors. Push down hard so that the teeth have pierced the PCB, close the connector. Please ensure the correct pin sequence is connected to the strip.

STEP 5:

Connector and LED strip must be inserted into the heat-shrink tube. The tube must be extended at least 2cm beyond the connector each side. For added weather proofing apply glue into of the tube.

STEP 6:

Heat the shrink tube using a heat-gun.

STEP 7:

Mounting the Strip:

- a. Self adhesive strip: Remove the protective film to reveal adhesive strip. Place the strip onto the desired location and press down firmly. Ensure the strip is secure.
- b. Clips: Place the strip along the desired position. Mark the locations where the clips are required, keeping them equally spaced. Fix clips to surface using screws. Check that the screws will not impinge on concealed cables or pipes.

STEP 8:

Connect the LED strip to LED drivers.

*** Note:** Strip is IP67 rated. When cut or joined the IP rating cannot be guaranteed.

Does not apply to RGBW IP67 flexi-strip

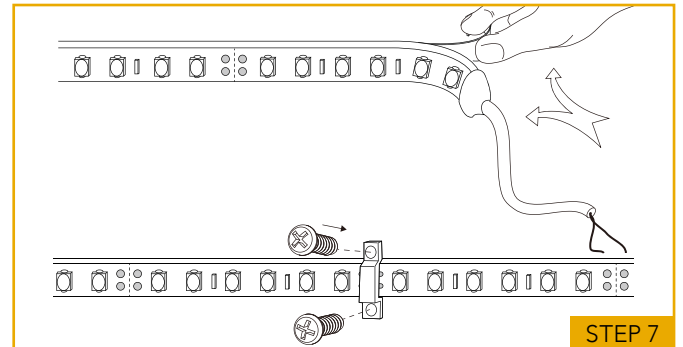
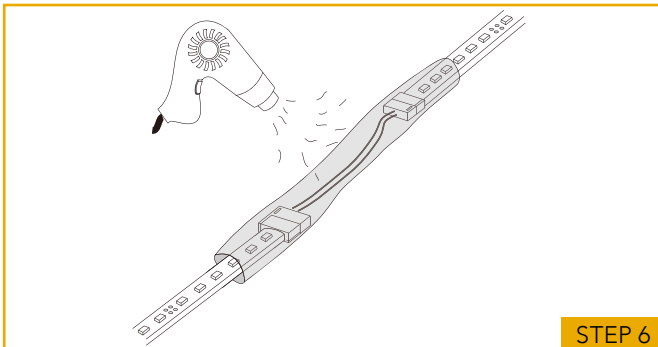
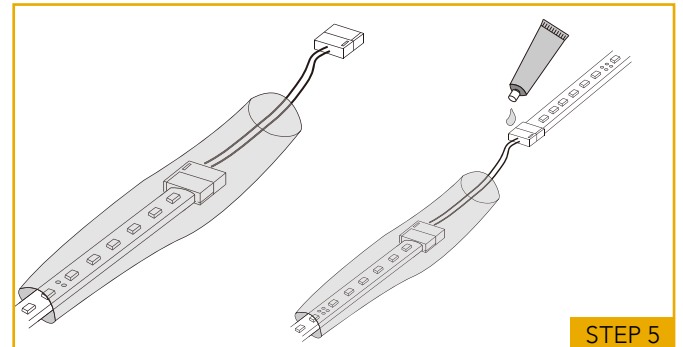
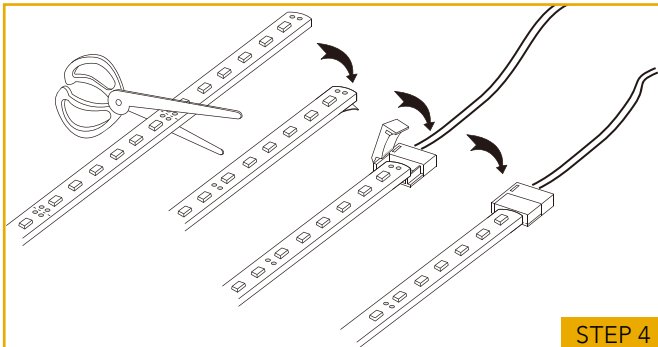
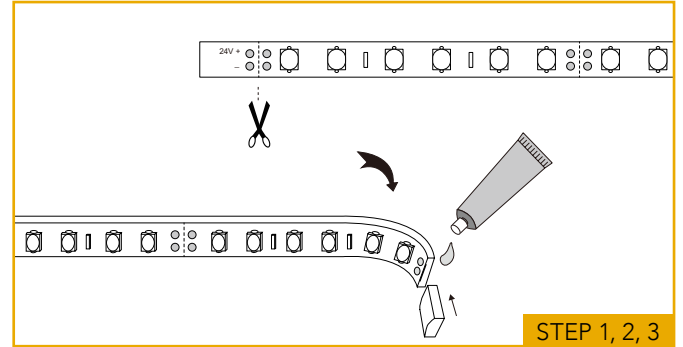
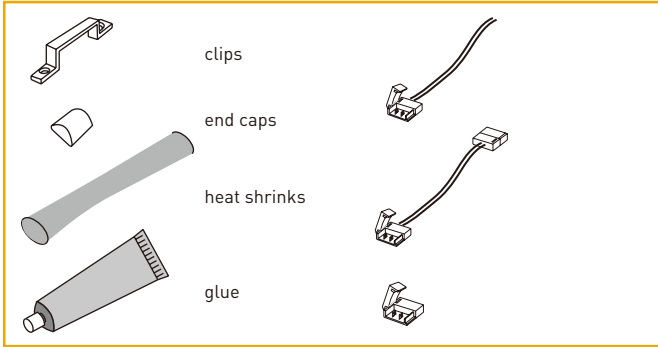



VEGAS CONTROLLERS & AMPLIFIERS

VEGAS LED FLEXI-STRIP CONTROLLERS & RECEIVERS	46
VEGAS LED FLEXI-STRIP AMPLIFIERS, IP RATED BOXES & WIRE	47
VEGAS CONNECT LED FLEXI-STRIP WIFI CONTROLLERS	48

VEGAS LED FLEXI-STRIP CONTROLLERS, RECEIVERS & AMPLIFIERS

VEGAS 4 ZONE RF REMOTE CONTROL FOR SINGLE COLOUR, RGB, RGBW



- Single Colour, RGB & RGBW dimming/colour changing remote control
- 2.4GHz RF technology providing up to 20M operation range
- 4 Independently programmable zones allowing complex lighting scenes



RVA4Z-RC

Total Power (W):	NA
Voltage:	NA
IP:	20
Length (mm):	180
Width (mm):	40
Height (mm):	20
Weight (kg):	0.15

VEGAS 4 CHANNEL RECEIVER FOR SINGLE COLOUR, RGB AND RGBW LED FLEXI STRIP



- Single Colour, RGB & RGBW dimming/colour changing receiver
- 2 remote options available
- Signal distance can be up to 30m
- Working voltage: 12-24V
- Connection mode: Common Anode



RVA4CH-REC

Total Power (W):	180/360
Voltage:	12-24VDC
IP:	20
Length (mm):	160
Width (mm):	46
Height (mm):	25
Weight (kg):	0.15

VEGAS AMPLIFIER, SINGLE COLOUR



- Signal amplifier for synchronous operation over long distance
- Only required when single colour flex-strip is dimmed for systems over 10m
- IP rated enclosure available (RVBIP2)
- Current: 6A x 2 channel
- Connection mode: Common Anode

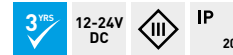

RVACCT1-AMP

Total Power (W):	144/288
Voltage:	12-24VDC
IP:	20
Length (mm):	80
Width (mm):	73
Height (mm):	34
Weight (kg):	0.13

VEGAS LED FLEXI-STRIP AMPLIFIERS, IP RATED BOXES & WIRE

VEGAS AMPLIFIER, RGB & RGBW



- Signal amplifier for synchronous operation over long distance
- Required for lengths longer than 5m RGB/RGBW
- IP rated enclosure available (RVBIP2)
- RGB Current: 6A x 3 Channel output power 216/432W; RGBW Current: 8A x 4 Channel, output power 384/768W
- Connection mode: Common Anode



	RVARGB-AMP	RVARGBW-AMP
Total Power (W):	216/432	384/768
Voltage:	12-24VDC	12-24VDC
IP:	20	20
Length (mm):	80	91
Width (mm):	73	88
Height (mm):	34	24
Weight (kg):	0.1	0.22

VEGAS IP RATED BOXES



Large Box	RVBIP2
IP:	65
Length (mm):	152
Width (mm):	153
Height (mm):	78
Weight (kg):	0.1

Small Box	RVBIP1
IP:	65
Length (mm):	94
Width (mm):	65
Height (mm):	55
Weight (kg):	0.1

VEGAS DC LINES WIRE



Single colour	RVACCT1W50
VEGAS 20WAG 2 Cores DC lines Wire for single colour LED Strip, 50m	

RGB	RVARGBW50
VEGAS 20WAG 4 Cores DC lines Wire for RGB LED strip, 50m	

RGBW	RVARGBW50
VEGAS 22WAG 5 Cores DC lines Wire for RGBW LED strip, 50m	

Note: Single Colour /RGB/RGBW controllers, remote controls and wall places can be paired so they won't effect other systems in the same area

VEGAS CONNECT LED FLEXI-STRIP WIFI CONTROLLERS

VEGAS CONNECT
LED FLEXI-STRIP WIFI
CONTROLLERS,
SINGLE COLOUR,
RGB & RGBW



ALLOWS VEGAS
FLEXI-STRIPS TO
BE CONTROLLED
WITH ROBUS
CONNECT APP
USING WIFI



- Single Colour, RGB & RGBW dimming controllers
- Controlled by ROBUS CONNECT App via WiFi
- Use with VEGAS range of drivers
- IP rated enclosure available: RVBIP2
- Connection mode: common anode

Product Code:	RVACCT1-WIFI	RVRGB-WIFI	RVRGBW-WIFI
Operating Voltage (Vdc)	12-24	12-24	12-24
Total Power (W):	120/240	120/240	120/240
Rated Life (hrs):	30,000	30,000	30,000
IP:	20	20	20
Output Current (A):	1 x 10A	3 x 5A (max 10A total)	4 x 5A (max 10A total)
Height (mm):	21	21	21
Length (mm):	99	99	99
Width (mm):	39	39	39
Weight (kg):	0.15	0.15	0.15





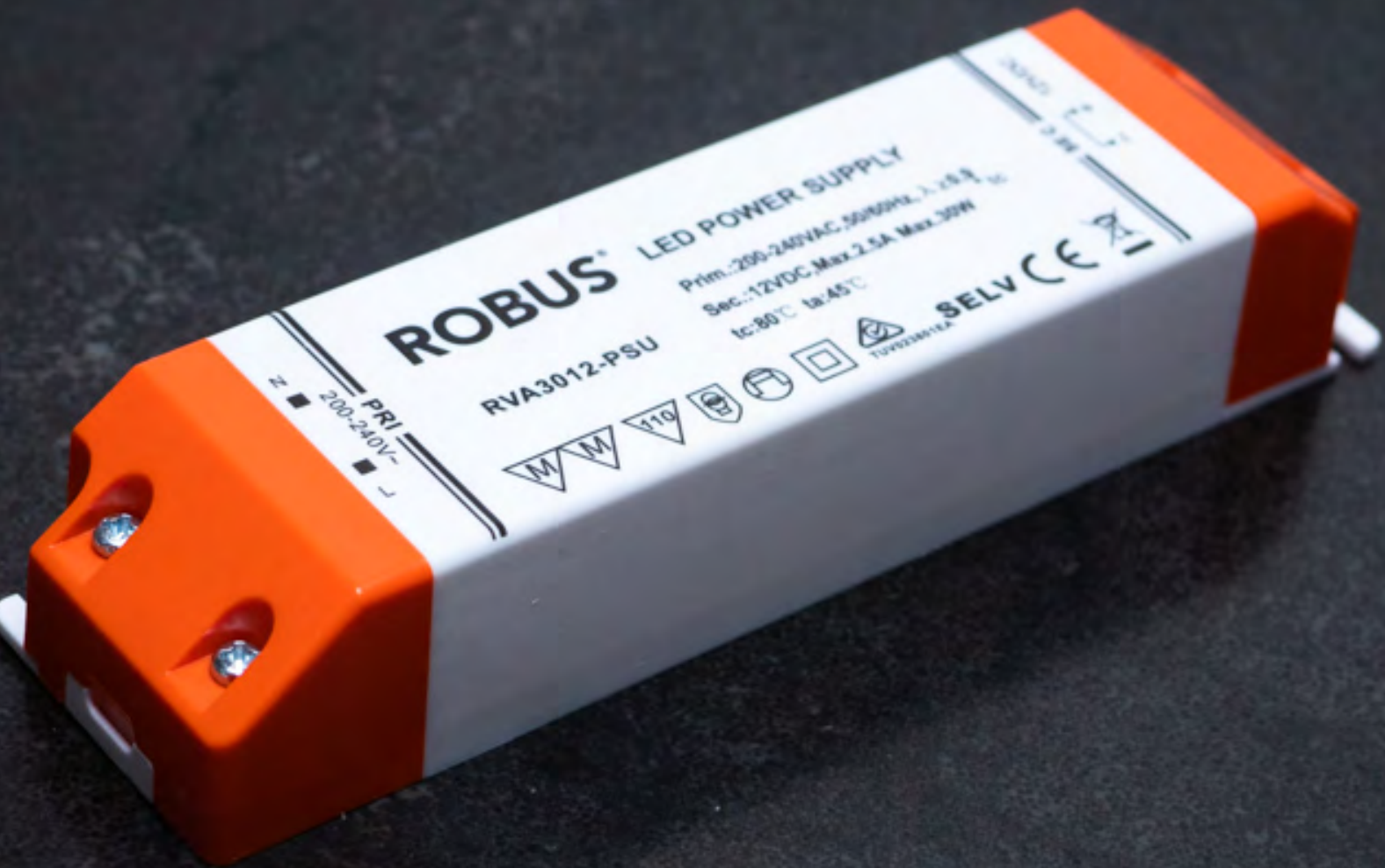

ROBUS LED POWER SUPPLY

RVA3012-PSU

Prim.: 200-240VAC, 50/60Hz, 1.2A
Sec.: 12VDC, Max. 2.5A, Max. 30W
tc: 80°C to 45°C

SELV CE

PRI
200-240V~

M M 10

VEGAS LED DRIVERS

VEGAS IP20 DRIVERS	52
VEGAS IP67 DRIVERS	54
VEGAS DRIVERS COMPATABILITY LISTS	55

VEGAS IP20 DRIVERS



12V NON-DIMMABLE & DIMMABLE DRIVERS

- IP20 for indoor applications only
- Constant voltage driver for use with 12V VEGAS LED flexi-strip range only
- Dimmable with traditional wall mounted dimmer switch
- Dimmable drivers compatible with selected leading and trailing edge dimmers - see page 57
- Minimum strip length to ensure proper dimming as per table below

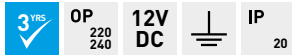

12V NON-DIMMABLE DRIVERS				
	30W	60W	100W	180W
	RVA3012-PSU	RVA6012-PSU	RVA10012-PSU	RVA18012-PSU
Total Power (W:)	30	60	100	180
Voltage:	12VDC	12VDC	12VDC	12VDC
IP:	20	20	20	20
Length (mm):	149	170	180	195
Width (mm):	40	44	65	67
Height (mm):	27	28	31	31
Weight (kg):	0.12	0.22	0.37	0.41



12V DIMMABLE DRIVERS			
	30W	50W	75W
	RVA3012DU-PSU	RVA5012DU-PSU	RVA7512DU-PSU
Total Power (W:)	30	50	75
Voltage:	12VDC	12VDC	12VDC
IP:	20	20	20
Length (mm):	158	158	170
Width (mm):	46	46	56
Height (mm):	18	18	31
Weight (kg):	0.12	0.21	0.3

MINIMUM 12V STRIP LENGTH TO ENSURE PROPER DIMMING

RVA3012DU-PSU	1m
RVA5012DU-PSU	3m
RVA7512DU-PSU	5m

VEGAS IP20 DRIVERS

24V NON-DIMMABLE & DIMMABLE DRIVERS

- IP20 for indoor applications only
- Constant voltage driver for use with 24V VEGAS LED flexi-strip range only
- Dimmable with traditional wall mounted dimmer switch
- Dimmable drivers compatible with selected leading and trailing edge dimmers - see page 57
- Minimum strip length to ensure proper dimming as per table below



24V NON-DIMMABLE DRIVERS						
	30W	60W	100W	150W	250W	320W
	RVA3024-PSU	RVA6024-PSU	RVA10024-PSU	RVA15024-PSU	RVA25024-PSU	RVA32024-PSU
Total Power (W:)	30	60	100	150	250	320
Voltage:	24VDC	24VDC	24VDC	24VDC	24VDC	24VDC
IP:	20	20	20	20	20	20
Length (mm):	149	170	180	180	195	215
Width (mm):	40	45	65	66	62	78
Height (mm):	27	28	31	31	36	35
Weight (kg):	0.12	0.22	0.37	0.41	0.42	0.44

24V DIMMABLE DRIVERS			
	30W	50W	75W
	RVA3024DU-PSU	RVA5024DU-PSU	RVA7524DU-PSU
Total Power (W:)	30	50	75
Voltage:	24VDC	24VDC	24VDC
IP:	20	20	20
Length (mm):	158	158	170
Width (mm):	46	46	56
Height (mm):	18	18	31
Weight (kg):	0.12	0.21	0.3



MINIMUM 24V STRIP LENGTH TO ENSURE PROPER DIMMING

RVA3024DU-PSU	1m
RVA5024DU-PSU	3m
RVA7524DU-PSU	3m

VEGAS IP67 DRIVERS



12V & 24V NON-DIMMABLE DRIVERS

- IP67 for indoor and outdoor applications
- Constant voltage driver for use with 12V & 24V VEGAS LED flexi-strip range only
- Non dimmable

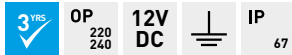

12V NON-DIMMABLE DRIVERS		
	100W	200W
	RVA10012IP67-PSU	RVA20012IP67-PSU
Total Power (W:)	100	200
Voltage:	12VDC	12VDC
IP:	67	67
Length (mm):	212	212
Width (mm):	46	46
Height (mm):	38	38
Weight (kg):	0.58	0.80



24V NON-DIMMABLE DRIVERS				
	60W	100W	200W	320W
	RVA6024IP67-PSU	RVA10024IP67-PSU	RVA20024IP67-PSU	RVA32024IP67-PSU
Total Power (W:)	60	100	200	320
Voltage:	24VDC	24VDC	24VDC	24VDC
IP:	67	67	67	67
Length (mm):	216	212	212	212
Width (mm):	42	46	46	46
Height (mm):	30	38	38	38
Weight (kg):	0.53	0.58	0.80	0.80

VEGAS DRIVERS

COMPATABILITY LISTS

SINGLE COLOUR LED FLEXI-STRIP

DIMMABLE 12V, IP20 FOR SINGLE COLOUR 4.8W/M LED FLEXI-STRIP

CODE	DESCRIPTION	METERS PER DRIVER
RVA3012DU-PSU	VEGAS 30W, 12V, IP20 driver, triac dimmable	1m – 6m
RVA5012DU-PSU	VEGAS 50W, 12V, IP20 driver, triac dimmable	7m – 10m
RVA7512DU-PSU	VEGAS 75W, 12V, IP20 driver, triac dimmable	11m – 15m

DIMMABLE 24V, IP20 FOR SINGLE COLOUR 9.6W/M LED FLEXI-STRIP

CODE	DESCRIPTION	METERS PER DRIVER
RVA3024DU-PSU	VEGAS 30W, 24V, IP20 driver, triac dimmable	1m – 3m
RVA5024DU-PSU	VEGAS 50W, 24V, IP20 driver, triac dimmable	4m – 5m
RVA7524DU-PSU	VEGAS 75W, 24V, IP20 driver, triac dimmable	6m – 7m

NON-DIMMABLE 12V, IP20 FOR SINGLE COLOUR 4.8W/M LED FLEXI-STRIP

CODE	DESCRIPTION	METERS PER DRIVER
RVA3012-PSU	VEGAS 30W, 12V, IP20 constant voltage driver, non-dimmable	4m – 6m
RVA6012-PSU	VEGAS 60W, 12V, IP20 constant voltage driver, non-dimmable	7m – 12m
RVA10012-PSU	VEGAS 100W, 12V, IP20 constant voltage driver, non-dimmable	13m – 20m
RVA18012-PSU	VEGAS 180W, 12V, IP20 constant voltage driver, non-dimmable	21m – 37m

NON-DIMMABLE 24V, IP20 FOR SINGLE COLOUR 9.6W/M LED FLEXI-STRIP

CODE	DESCRIPTION	METERS PER DRIVER
RVA3024-PSU	VEGAS 30W, 24V, IP20 constant voltage driver, non-dimmable	2m – 3m
RVA6024-PSU	VEGAS 60W, 24V, IP20 constant voltage driver, non-dimmable	4m – 6m
RVA10024-PSU	VEGAS 100W, 24V, IP20 constant voltage driver, non-dimmable	7m – 10m
RVA15024-PSU	VEGAS 150W, 24V, IP20 constant voltage driver, non-dimmable	11m – 15m
RVA25024-PSU	VEGAS 250W, 24V, IP20 constant voltage driver, non-dimmable	16m – 26m
RVA32024-PSU	VEGAS 320W, 24V, IP20 constant voltage driver, non-dimmable	27m – 33m

NON-DIMMABLE 12V, IP67 FOR SINGLE COLOUR 4.8 W/M LED FLEXI-STRIP

CODE	DESCRIPTION	METERS PER DRIVER
RVA10012IP67-PSU	VEGAS 100W, 12V, IP67 constant voltage driver, non-dimmable	13m – 20m
RVA20012IP67-PSU	VEGAS 200W, 12V, IP67 constant voltage driver, non-dimmable	21m – 41m

NON-DIMMABLE 24V, IP67 FOR SINGLE COLOUR 9.6 W/M LED FLEXI-STRIP

CODE	DESCRIPTION	METERS PER DRIVER
RVA6024IP67-PSU	VEGAS 60W, 24V, IP67 constant voltage driver, non-dimmable	1m – 6m
RVA10024IP67-PSU	VEGAS 100W, 24V, IP67 constant voltage driver, non-dimmable	7m – 10m
RVA20024IP67-PSU	VEGAS 200W, 24V, IP67 constant, voltage driver, non-dimmable	11m – 20m
RVA32024IP67-PSU	VEGAS 320W, 24V, IP67 constant, voltage driver, non-dimmable	21m – 31m

Note: IP20 drivers can be used together with IP rated boxes if exposed to water.

VEGAS DRIVER COMPATABILITY LISTS

RGB / RGBW COLOUR CHANGING FLEXI-STRIP

NON-DIMMABLE 12V, IP20 FOR RGB 7.2W/M LED FLEXI-STRIP

CODE	DESCRIPTION	METERS PER DRIVER
RVA3012-PSU	VEGAS 30W, 12V, IP20 constant voltage driver, non-dimmable	3m – 4m
RVA6012-PSU	VEGAS 60W, 12V, IP20 constant voltage driver, non-dimmable	5m – 8m
RVA10012-PSU	VEGAS 100W, 12V, IP20 constant voltage driver, non-dimmable	9m – 13m
RVA18012-PSU	VEGAS 180W, 12V, IP20 constant voltage driver, non-dimmable	14m – 25m

NON-DIMMABLE 24V, IP20 FOR RGB 14.4W/M LED FLEXI-STRIP

CODE	DESCRIPTION	METERS PER DRIVER
RVA3024-PSU	VEGAS 30W, 24V, IP20 constant voltage driver, non-dimmable	2m
RVA6024-PSU	VEGAS 60W, 24V, IP20 constant voltage driver, non-dimmable	3m – 4m
RVA10024-PSU	VEGAS 100W, 24V, IP20 constant voltage driver, non-dimmable	5m – 6m
RVA15024-PSU	VEGAS 150W, 24V, IP20 constant voltage driver, non-dimmable	7m – 10m
RVA25024-PSU	VEGAS 250W, 24V, IP20 constant voltage driver, non-dimmable	11m – 17m
RVA32024-PSU	VEGAS 320W, 24V, IP20 constant voltage driver, non-dimmable	18m – 22m

NON-DIMMABLE 12V, IP67 FOR RGB 7.2W/M LED FLEXI-STRIP

CODE	DESCRIPTION	METERS PER DRIVER
RVA10012IP67-PSU	VEGAS 100W, 12V, IP67 constant voltage driver, non-dimmable	9m – 13m
RVA20012IP67-PSU	VEGAS 200W, 12V, IP67 constant voltage driver, non-dimmable	14m – 27m

NON-DIMMABLE 24V, IP67 FOR RGB 14.4W/M LED FLEXI-STRIP

CODE	DESCRIPTION	METERS PER DRIVER
RVA6024IP67-PSU	VEGAS 60W, 24V, IP67 constant voltage driver, non-dimmable	1m – 4m
RVA10024IP67-PSU	VEGAS 100W, 24V, IP67 constant voltage driver, non-dimmable	5m – 6m
RVA20024IP67-PSU	VEGAS 200W, 24V, IP67 constant voltage driver, non-dimmable	7m – 13m
RVA32024IP67-PSU	VEGAS 320W, 24V, IP67 constant voltage driver, non-dimmable	14m – 22m

NON-DIMMABLE 24V, IP20 FOR RGBW 12W/M LED FLEXI-STRIP

CODE	DESCRIPTION	METERS PER DRIVER
RVA3024-PSU	VEGAS 30W, 24V, IP20 constant voltage driver, non-dimmable	2m
RVA6024-PSU	VEGAS 60W, 24V, IP20 constant voltage driver, non-dimmable	3m – 5m
RVA10024-PSU	VEGAS 100W, 24V, IP20 constant voltage driver, non-dimmable	6m – 8m
RVA15024-PSU	VEGAS 150W, 24V, IP20 constant voltage driver, non-dimmable	9m – 12m
RVA25024-PSU	VEGAS 250W, 24V, IP20 constant voltage driver, non-dimmable	13m – 20m
RVA32024-PSU	VEGAS 320W, 24V, IP20 constant voltage driver, non-dimmable	21m – 26m

VEGAS DRIVER COMPATABILITY LISTS

RGB / RGBW COLOUR CHANGING FLEXI-STRIP

NON-DIMMABLE 24V, IP67 FOR RGBW 12W/M LED FLEXI-STRIP

CODE	DESCRIPTION	METERS PER DRIVER
RVA6024IP67-PSU	VEGAS 60W, 24V, IP67 constant voltage driver, non-dimmable	1m – 5m
RVA10024IP67-PSU	VEGAS 100W, 24V, IP67 constant voltage driver, non-dimmable	6m – 8m
RVA20024IP67-PSU	VEGAS 200W, 24V, IP67 constant voltage driver, non-dimmable	7m – 16m
RVA32024IP67-PSU	VEGAS 320W, 24V, IP67 constant voltage driver, non-dimmable	17m – 26m





VEGAS ALUMINIUM EXTRUSIONS

VEGAS ALUMINIUM EXTRUSIONS

60

VEGAS ALUMINIUM EXTRUSIONS

EXTRUSION, SURFACE MOUNTED, 8MM



- Surface mounted
- Low profile extrusion with push on PC diffuser
- Anodised aluminium
- Supplied in 2m lengths complete with end caps and mounting clips
- For single-colour and RGB VEGAS flexi-strip

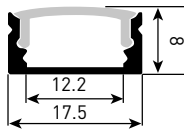

REXS082-23

Length (m):	2
Width (mm):	12.2
Height (mm):	8
Weight (kg):	0.12

EXTRUSION, SURFACE MOUNTED, 12.5MM



- Surface mounted extrusion with push on PC diffuser
- Anodised aluminium
- Supplied in 2m lengths complete with end caps
- Wide base to fit VEGAS RGBW flexi-strip

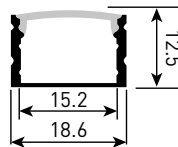

REXS122-23

Length (m):	2
Width (mm):	18.6
Height (mm):	12.5
Weight (kg):	0.12

EXTRUSION, RECESSED, 15MM



- Recessed extrusion with push on PC diffuser
- Anodised aluminium
- Supplied in 2m lengths complete with end cap
- For single-colour and RGB VEGAS flexi-strip

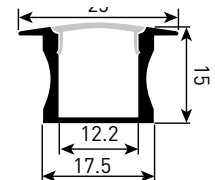

REXR152-23

Length (m):	2
Width (mm):	12.2
Height (mm):	15
Weight (kg):	0.23

VEGAS ALUMINIUM EXTRUSIONS

EXTRUSION, RECESSED, 12.5MM



- Recessed extrusion with push on PC diffuser
- Anodised aluminium
- Supplied in 2m lengths complete with end caps
- Wide base to fit VEGAS RGBW flexi-strip

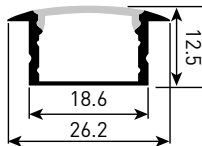

REXR122-23

Length (m):	2
Width (mm):	18.6
Height (mm):	12.5
Weight (kg):	0.12

EXTRUSION, ANGLED, 45°



- 45° angled extrusion for use in corner installations
- Push on PC diffuser
- Anodised aluminium
- Supplied in 2m lengths complete with end caps and mounting clips
- For single-colour and RGB VEGAS flexi-strip

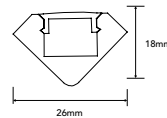

REXA172-23

Length (m):	2
Width (mm):	26
Height (mm):	18
Weight (kg):	1

EXTRUSION, ANGLED, 45°, WIDE BASE



- 45° angled extrusion for use in corner installations
- Wide base to fit VEGAS RGBW LED Flexi-strip
- Anodised aluminium
- Supplied in 2m lengths complete with end caps and mounting clips
- Wide base to fit VEGAS RGBW flexi-strip

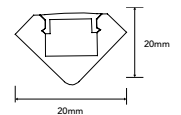

REXA202-23

Length (m):	2
Width (mm):	20
Height (mm):	20
Weight (kg):	1





The Park Shopping Centre,
Carrickmines, Dublin, Ireland





181

+ DC12V

+ DC12V



LED GROUP EUROPE · AUSTRALIA · NEW ZEALAND · ASIA · MIDDLE EAST · AFRICA

AUSTRALIA OFFICE

9/210 QUEENSPORT ROAD
MURARRIE QLD 4172
AUSTRALIA
TEL: +61 7 3890 5444



NEW ZEALAND OFFICE

CROWE HORWATH
72 TRAFALGAR STREET
NELSON 7010
NEW ZEALAND
TEL: +64 3 668 5285

HEAD OFFICE

NANGOR ROAD,
DUBLIN 12,
D12 E7VP, IRELAND
TEL: +353 1 709 9000

E. PURCHASES@LEDGROUPOBUS.COM.AU
WWW.ROBUS.COM.AU
WWW.ROBUSGO.COM.AU

 [ROBUSLIGHTING](#)
 [ROBUSLIGHTING](#)
 [LED-GROUP](#)