

ROBUS®

COMMERCIAL

SPEEDBEAM EXPRESS

10/20W, 18/34W, 26/51W, 32/65W, IP20



PRODUCT INFORMATION DOCUMENT

FEATURES

- Easy to open screw-less end caps providing quick and simple installation
- Two-part construction making wiring and installation much easier and faster
- Modularised components for quick and easy replacement
- All sizes equipped with quick connectors allowing plug-in emergency pack (R3EMP2N-04) and plug-in microwave sensor (RHEMW-04) to be fitted in seconds. Compatible with suspension kit (RAESUS-2W)
- Light colour temperature selectable between 3000K, 4000K and 6500K
- Unique design of each size allowing selection between 2 different lumen outputs to suit installation area requirements

CONSTRUCTION

- Pressed steel, powder coated base
- Polycarbonate diffuser and end caps
- 4-way push terminals

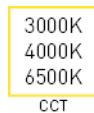
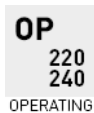
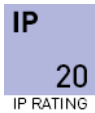
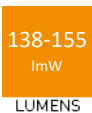

Product Code:	RSBEX06-01	RSBEX12-01	RSBEX15-01	RSBEX15E-01	RSBEX18-01
Comparable to:	1x/2x36W T8	1x/2x58W T8	1x/2x58W T8	1x/2x58W T8	1x/2x70W T8
Total Power (W):	9.9/19.1	17.9/34.2	24.7/49.9	27.4/51.8	34/68
Power Factor:	0.9	0.9	0.9	0.9	0.9
Total Light Output (lm):	1530/2690	2710/4940	4060/7440	4060/7410	4940/9100
Total Emergency Light Output (lm):	330	330	330	330	330
Efficacy (lm/cctW):	155/141	152/144	154/145	148/143	153/138
Lux at 1m (lux):	480/850	820/1510	1210/2210	1210/2210	1400/2580
Emergency Lux at 1m (lux):	100	100	100	100	100
CCT (K):	3000/4000/6500	3000/4000/6500	3000/4000/6500	3000/4000/6500	3000/4000/6500
CRI:	80	80	80	80	80
IP:	20	20	20	20	20
Operation Temperature (°C):	-20 ≤ Ta ≤ +40	-20 ≤ Ta ≤ +40	-10 ≤ Ta ≤ +40	-10 ≤ Ta ≤ +40	-20 ≤ Ta ≤ +40
Inrush Current:	12.9A/196us	14.5A/195us	14.5A/195us	14.5A/195us	17.5A/210us
RG Value:	0	0	0	0	0
SDCM:	6	6	6	6	6
Energy Class:	D	D	D	D	D
Rated Life to L70B50 (Hrs):	173000	173000	173000	173000	173000
Rated Life to L80B10 (Hrs):	60000	60000	60000	60000	60000
Rated Life to L90B10 (Hrs):	50000	50000	52000	52000	49000
Dimensions LxWxH (mm):	630x72x66	1230x72x66	1530x72x66	1530x72x66	1830x72x66
Weight (kg):	0.75	1.31	1.65	1.78	2.05

Separate Control Gear Information					
Type of Light Source:	LED	LED	LED	LED	LED
Full Load Efficiency (%):	91	92	93	93	93
P _{NET} (W):	NA	NA	NA	NA	NA
Dimensions (mm):	140x44x26	176x44x26	213x44x26	213x44x26	213x44x26

Product is certified to all the relevant standards.

Please contact our technical department for market specific compliances.

PLEASE NOTE: INFORMATION IN THIS DOCUMENT MAY BE SUBJECT TO CHANGE WITHOUT PRIOR NOTICE

IRE: TEL: +353 1 709 9000
 UK: TEL: 0800 973 220
 AUS: TEL: +61 7 3890 5444
 NZ: TEL: +64 03 668 5285

WEB: ROBUS.COM
 WEB: ROBUS.COM
 WEB: ROBUS.COM.AU
 WEB: ROBUSLED.CO.NZ

LED GROUP EUROPE · UK · AUSTRALIA · NEW ZEALAND · ASIA · MIDDLE EAST · AFRICA

SPEEDBEAM EXPRESS

10/20W, 18/34W, 26/51W, 32/65W, IP20

Cone Illuminance Diagram

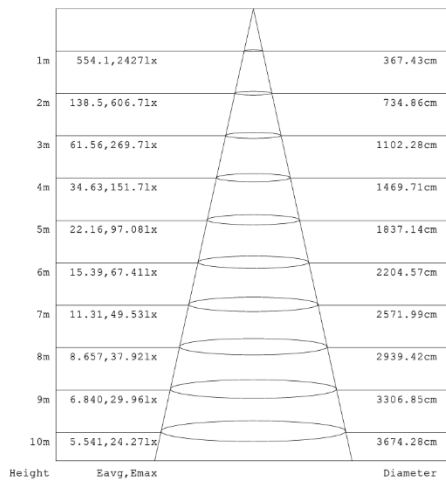
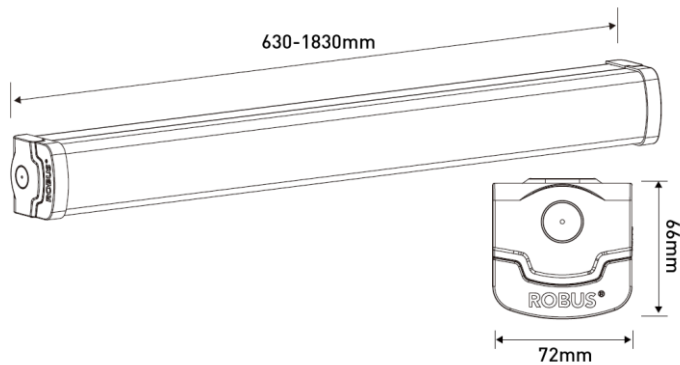

Diagram for RSBEX18-01 in 65W, 4000K. Other diagrams available on request

Dimension Diagram



Sensor Data

Time Off Delay:	5s to 10min
Illuminance Switching Range:	2lux to 50lux, disabled
Sensitivity Range (%):	50%, 100%
Mounting Height (max):	5m
Detection Zone Diameter (max):	10m

Polar Intensity Diagram

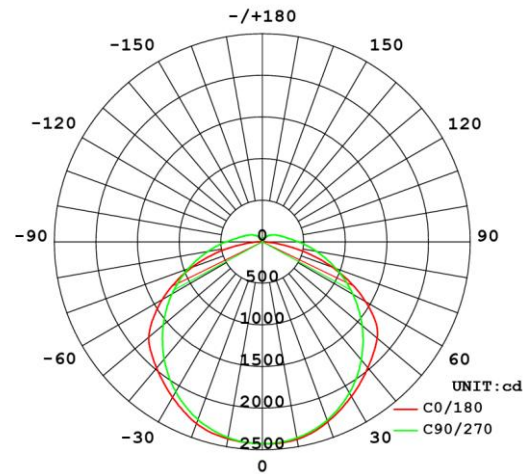

Diagram for RSBEX18-01 in 65W, 4000K. Other diagrams available on request

Accessories

R3EMP2N-04	Plug-in Emergency Pack For Linear Express
RHEMW-04	Plug-in Microwave, 3 Step Dimming Sensor
RAESUS-2W	2 Wire Suspension Kit For SPEEDBEAM