

Laying instructions:

speed•pipe® bundle ground SRV-G / SRV-G tc



Publisher

gabo Systemtechnik GmbH
Am Schaidweg 7
DE-94559 Niederwinkling
phone: 0049 (0)9962 950 200
fax: 0049 (0)9962 950 202
www.gabocom.com

Business division gabocom

Author: Alexander Geiger;

Approval: Markus Karl;

Edition 16 August 2017

The current version of this laying instruction is available in the download area "publication" under www.gabocom.com.

After leaving gabo Systemtechnik this document is not subject to be changed.
No responsibility is taken for the correctness, timeliness and completeness of details and information. Liability for damages is excluded.

Table of Contents

1. General	4
2. Utilisation of speedpipe® bundle ground	6
2.1 speedpipe® bundle ground tight covered SRV-G tc	6
2.2 speedpipe® bundle ground with flexible coating pipe SRV-G	8
3. Laying instructions SRV-G tc	9
4. Installations for SRV-G tc in direct laying in the ground	11
4.1 In open trenches	11
4.2 Ploughing	15
4.3 Laying with water drilling	16
4.4 Laying with Micro- and Minitrenching	17
5: Pulling SRV-G in existing ducts	18
5.1 Pulling in SRV-G in existing ducts (>Ø80mm)	18
5.2 Pulling in speedpipe®-ground from the SRV-G into existing ducts (Ø32-63mm)	23
6. Tensile forces	25
6.1 SRV-G tc variations	25
6.2 SRV-G variations	26
7. Laying temperatures	27
8. Opening of speedpipe® bundle ground	27
9. Cutting speedpipe® / speedpipe® bundle ground	28
10. Bending radius	29
11. Branching off from the speedpipe® bundle ground	31
12. Connecting speedpipe® bundle ground	34
13. Blowing in micro cables	34
14. Photographs from practice	40
14.1 SRV-G tc open trench	40
14.2 Ploughing	42
14.3 Pulling in speedpipe-ground from the SRV-G into existing ducts	43
15. Colour code	44
15.1 Colour code gabocom	44
15.2 Colour code DIN	47

1. General

The speedpipe® bundle ground and the internal speedpipe®-ground must be protected against contamination and mechanical damage during transport, storage and processing.

Any damage and deformation of the speedpipe ground (e.g. ovalisation /crushing etc.) must be avoided and cause a decrease in the blowing distance of the micro cables.

The speedpipe®-ground ends must be protected against the penetration of dirt and water by means of dust covers (protection against dust, dirt and splashing water, not pressure-tight), end plugs ES (pressure-tight up to 0,5 bar) or sealing elements EZA-t (pressure-tight up to 0,5 bar).

When storing them over a long period of time (several months) the speedpipe® bundle must be protected against direct solar radiation.

The laying instructions are significant for the realisation of the construction and installation work.

Transport notes :

- Don't damage the coil by lifting
- When lifting the coil don't burden the speedpipe bundle ground
- Don't lay the coil down!
- During transport never charge the lashing straps at the bundle

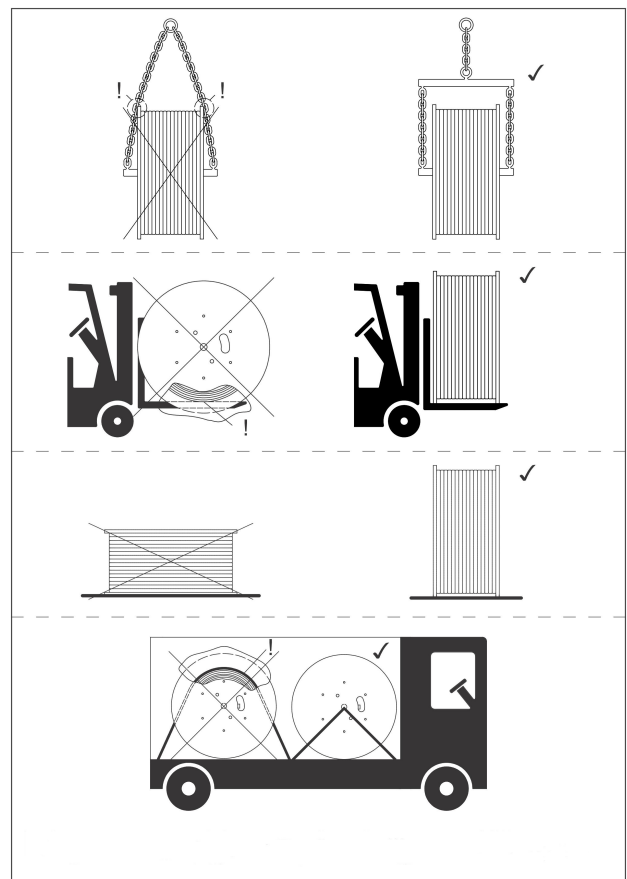

Using matching shafts for the spools of speedpipe-bundle

All spools (wood and steel) have a through bore of 125mm for receiving tubular steel drum shafts.

The speedpipe®-bundle can hereby raised up with the tubular steel drum shaft or handled in a drum winder.

Is there no suitable tubular steel drum shaft available with the correct diameter we recommend to use locating cones or

stepped bushes (e.g. company Vetter), for adaption of various shaft diameters.

These ensure a smooth running during unwinding of the speedpipe®-bundle and avoid knocking out/ ovalisation or even a defect of the through bore.



locating cones; Vetter

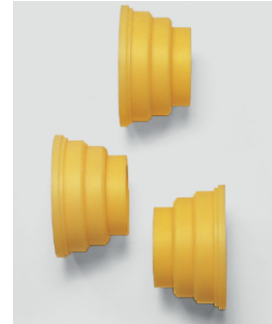

stepped bushes; Vetter



Example of a drum shaft suspension with a locating cone; Vetter

Note regarding root penetration:

In general there isn't a hundred percent protection against root penetration possible, with the exception of use of filling material with less pores. The easiest and well-known way is the compliance to hold a minimum distance between trace and root.

Here is valid: Minimum distance > crest width (of the tree, bush etc.)

Minimum distance to external installation

At paralleling and crossroads with external installation are appropriate safety precautions according table to provide:

External installation	Paralleling in m	Crossroads in m
Power supply line (particularly high-voltage)	0,3	0,3
Other communication systems	0,1	0,3
Gas-/ water-pipeline	0,8	1,0
District heating plant lines	0,8	1,0

Note the details about distances of the manufacturer of the external installation also in every case!

2. Utilisation of speedpipe® bundle ground

2.1 speedpipe® bundle ground tight covered SRV-G tc

The speedpipe® bundles consist of different colored speedpipe®-ground, which are tight covered with a coating pipe. The speedpipe® ground tc are suitable for laying procedures of point 4.

A.) Customer connection network

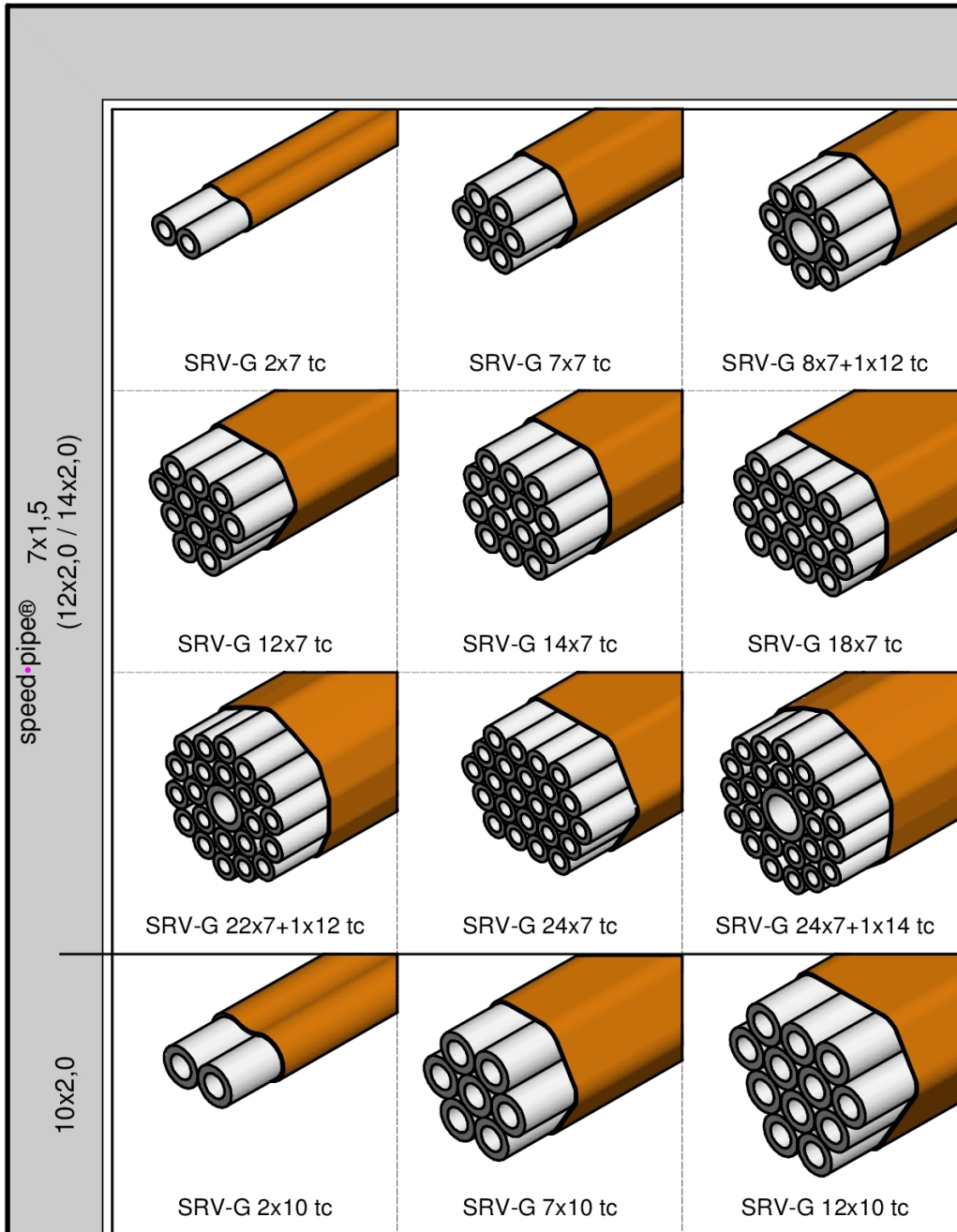



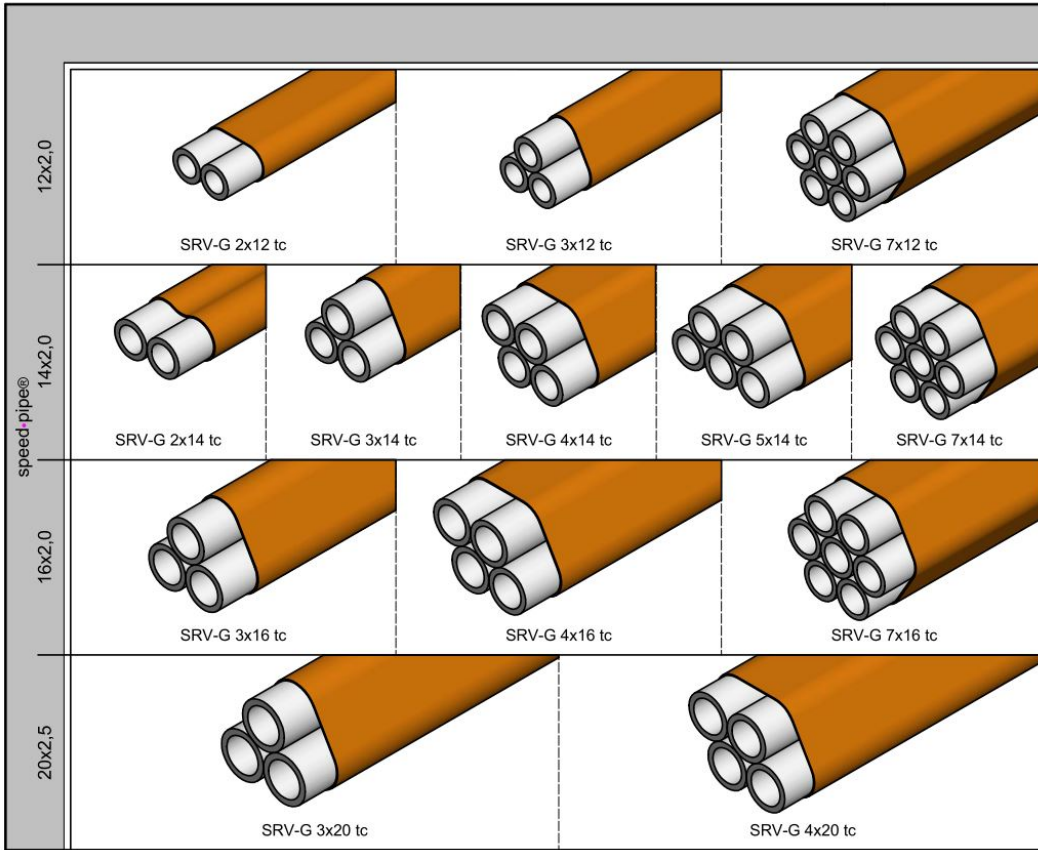





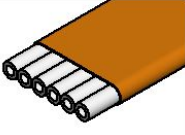
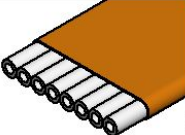
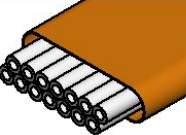
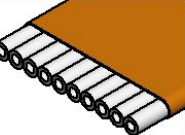
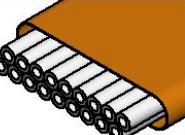
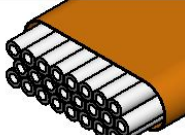

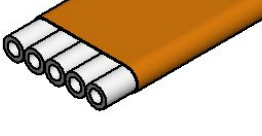
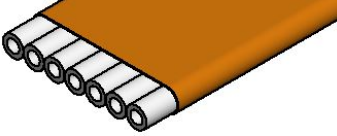
B.) Acces network

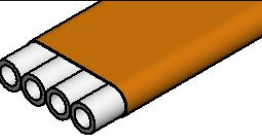
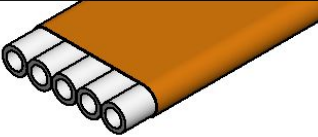

2.2 speedpipe® bundle ground with flexible coating pipe SRV-G

The speedpipe® bundles consist of different colored speedpipe®-ground, which are bundled with a flexible coating pipe. The speedpipe® ground are suitable for all laying procedures of point 5.

	jacket pipe Ø32	jacket pipe Ø40		jacket pipe Ø50		
7x1,5	 SRV-G 32 / 6x7	 SRV-G 40 / 8x7	 SRV-G 40 / 14x7	 SRV-G 50 / 10x7	 SRV-G 50 / 18x7	 SRV-G 50 / 24x7
10x2,0	 SRV-G 32 / 4x10	 SRV-G 40 / 5x10		 SRV-G 50 / 7x10		
12x2,0	 SRV-G 32 / 3x12	 SRV-G 40 / 4x12		 SRV-G 50 / 5x12		
14x2,0		 SRV-G 40 / 3x14		 SRV-G 50 / 4x14	 SRV-G 50 / 5x14	
16x2,0		 SRV-G 40 / 3x16		 SRV-G 50 / 4x16		

3. Laying instructions SRV-G tc

For an optimal laying the speedpipe® bundle must be uncoiled under tension because of physical reasons. For this the bundle has to be controlled decelerated during uncoiling. For the adjustment of the correct braking force, the laying temperature and the version of the speedpipe® bundle is deciding. Generally the braking force has to be increased accordingly during low laying temperatures and high quantity of speedpipe®. The permitted tensile forces (see point 6) aren't allowed to be exceeded.

For a professional laying the following points have to be considered:

- 1.) Laying of the SRV-G tc during the whole uncoiling under tension (from the first meter). For this purpose tighten possible loose layers on the spool before uncoiling.
- 2.) Braking force
It is necessary:
The more corrugated the laying is, the braking force has to be increased.
The lower the outside temperature is, the braking force has to be increased.
- 3.) After uncoiling fix the last layer of the SRV-G on the spool that the remaining layers on the spool cannot be untightened. Therefore the requirements for the next uncoiling are prepared.

Recommendation of equipment:

For an expert laying we recommend to use professional equipment and refer to appropriate spool brakes. These spool brakes allow a constant and controlled brake during uncoiling of the bundle and avoid an uncontrolled unrolling. The compatibility with the according trailers and racks has to be clarified with the respective producers.



drum band brake – Vetter



drum brake - Bagela



winding SRV-G tc up

professional

(linear laying of bundle under tension / spool is slowed down in a controlled manner)

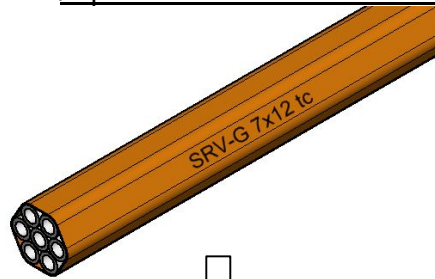

optimum blowing in length of the cables

unprofessional

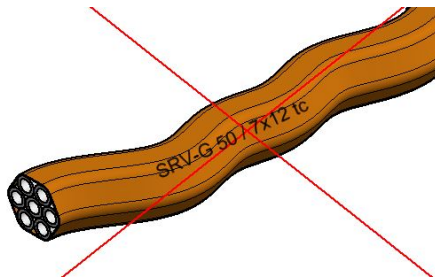

decrease in the blowing distance of the cables

4. Installations for SRV-G tc in direct laying in the ground

The following topics under point 4 apply for SRV-G tc and for the application of a speedpipe®-ground as a single microduct.

The structurally engineered specifications and standards for the following laying procedures have to be fulfilled and clarified with the according administrations.

4.1 In open trenches

The SRV-G tc must not be wound off by rolling the drum over the ground. By doing so there is the risk to squeeze the speedpipe®-ground. Therefore always a trailer for drums or a laying carriage must be used.

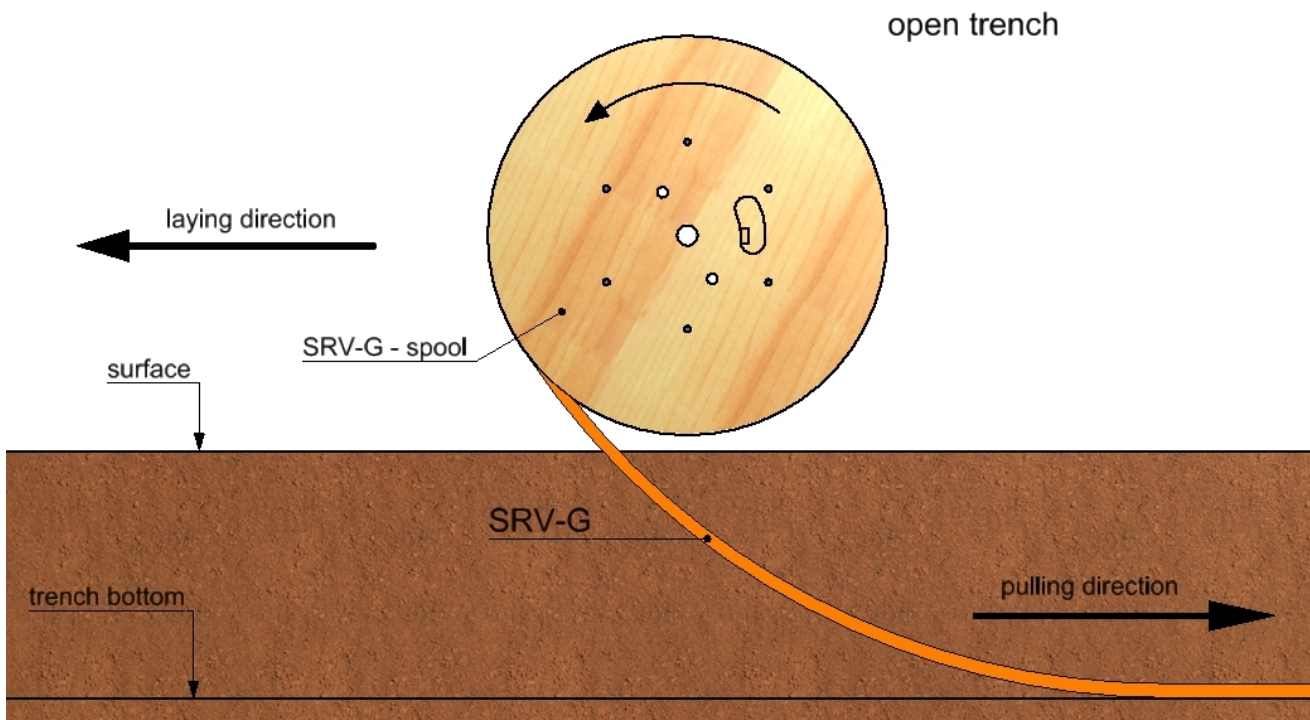

The SRV-G tc must be wound off the coil as described in the illustration (see picture). It is particularly important to respect the linear laying under tension (spool slowed down in a controlled manner)

It is not permitted to unwind the SRV-G tc on the flange (in direction of the coil axis, because of spiral forming of the SRV-G tc).

Avoid a wave like laying (neither horizontal nor vertical) coercively.

professional laying

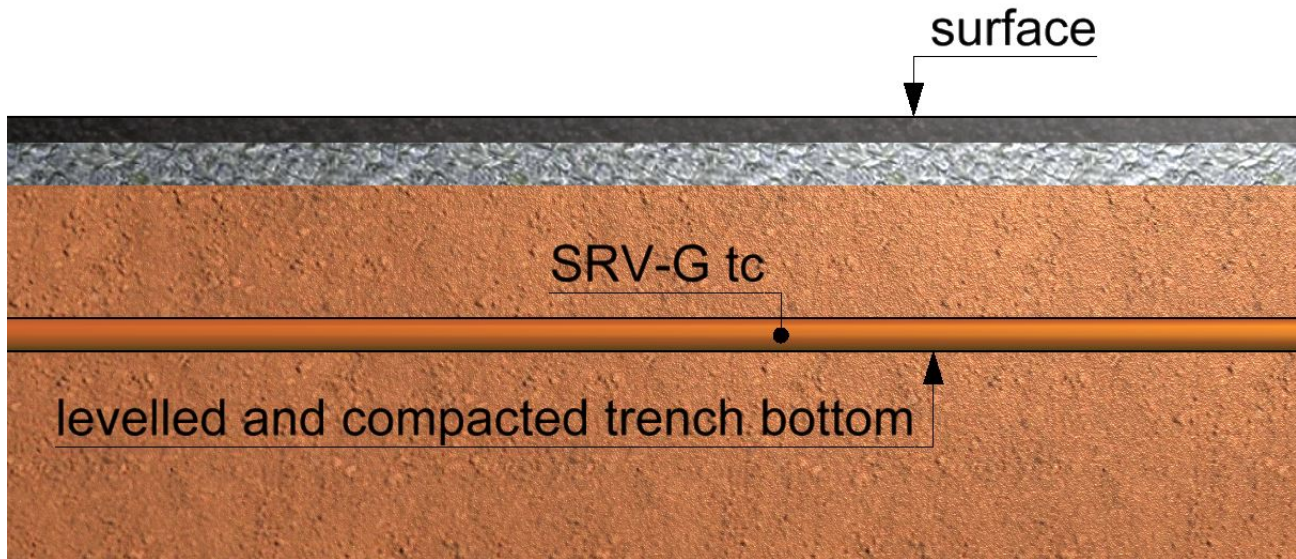

The trench bottom should be plane. In case the bottom is undulating e.g. due to an excavator, this section must be compensated.

unprofessional laying

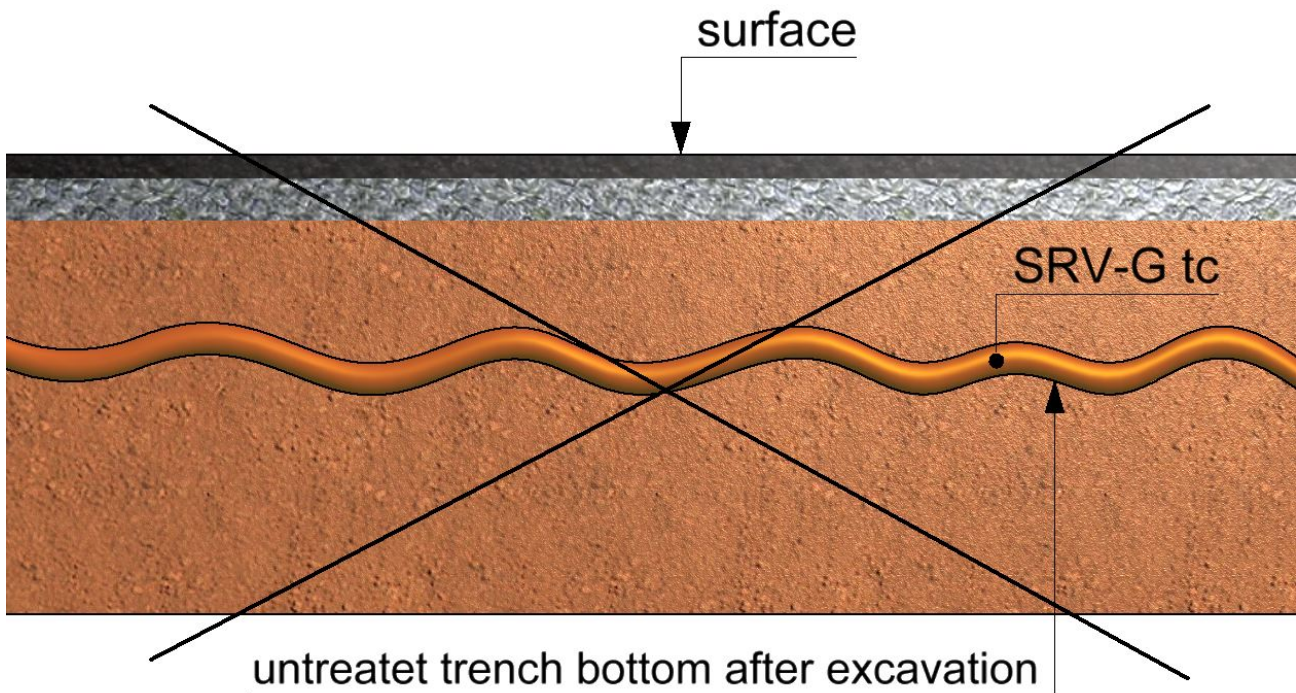

Here the undulating trench bottom was not compensated und thus it is transferred to the bundle. A considerable decrease in the blowing in length is to be expected!

Trench bottom and duct bedding

For the trench bottom and the duct bedding only compactable and stone-free material may be used. Before the laying process the trench bottom must be gently vibrated with a compactor. Pay attention to an even compacting. Mechanical compacting equipment is not allowed under 30 cm depth of coverage.

In case of rocky or stony subsoil the trench bottom must be excavated at least 0,15 m deeper and the excavation must be replaced by a stone-free layer (sand 0-6, with maximum grain size \varnothing 6 mm). After laying fill in tense state the embedment with 10cm sand over the peak of the speedpipe®-bundle
(see ZTV-TKNetz 10 / 11 and laying instructions for direct buried cable ducts out of PE-HD).

Example for an optimal duct bedding:

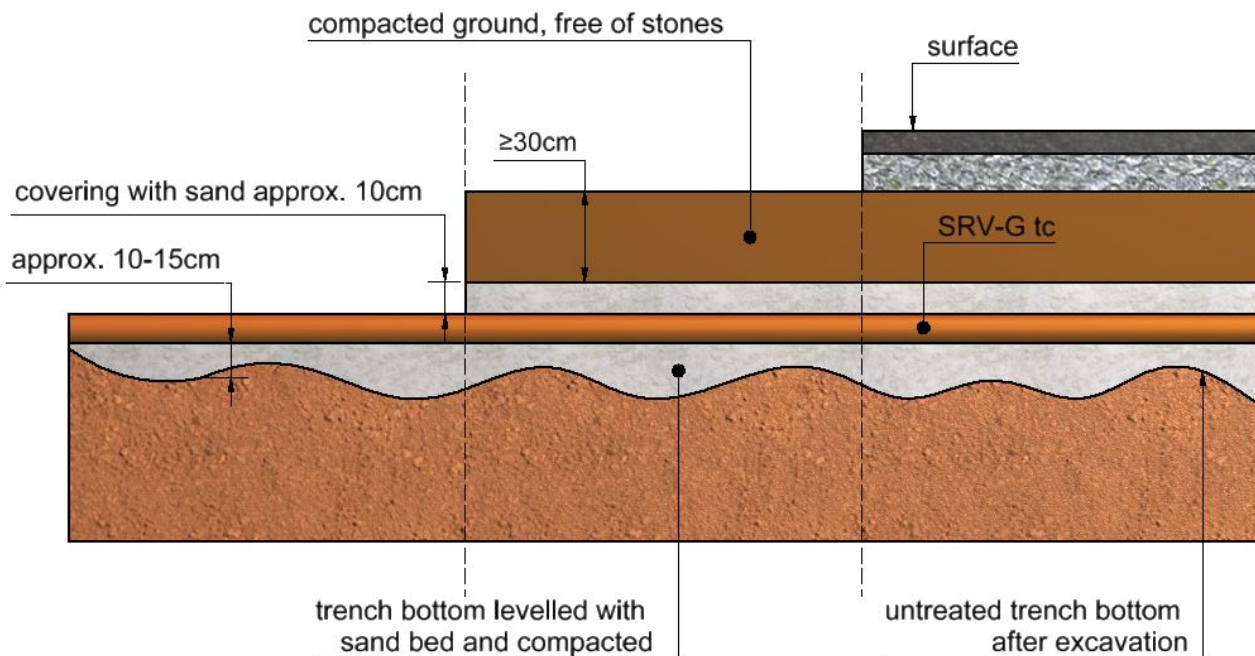

Laying of SRV-G tc in one deposition side by side

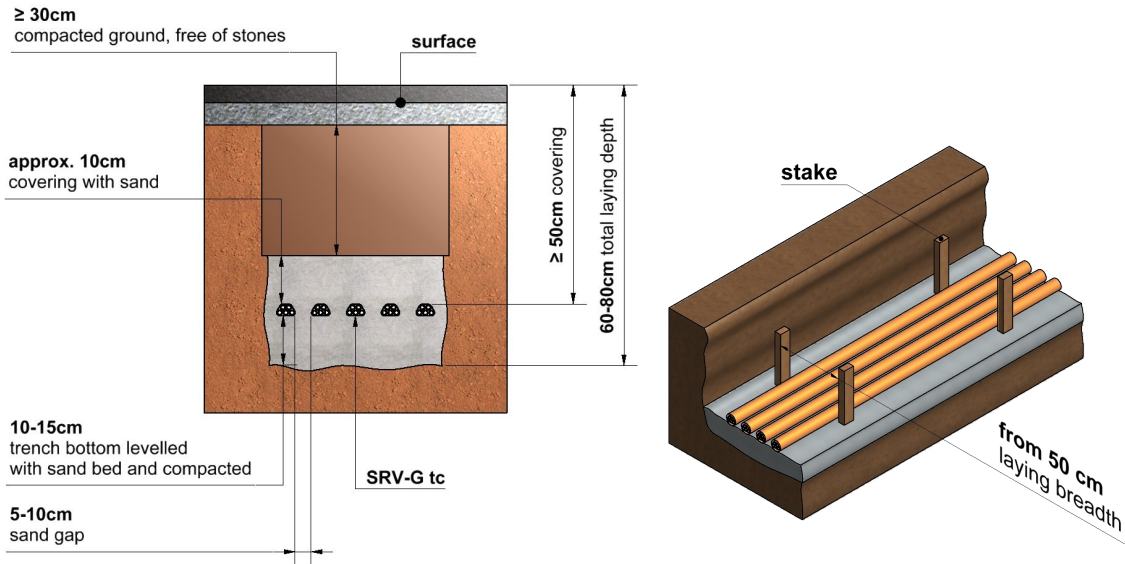

It is possible to install several SRV-G tc in one deposition without distance between them. At wider trenches than 50 cm it's recommended to stake out the layers for a better order.

Laying of SRV-G tc in several depositions

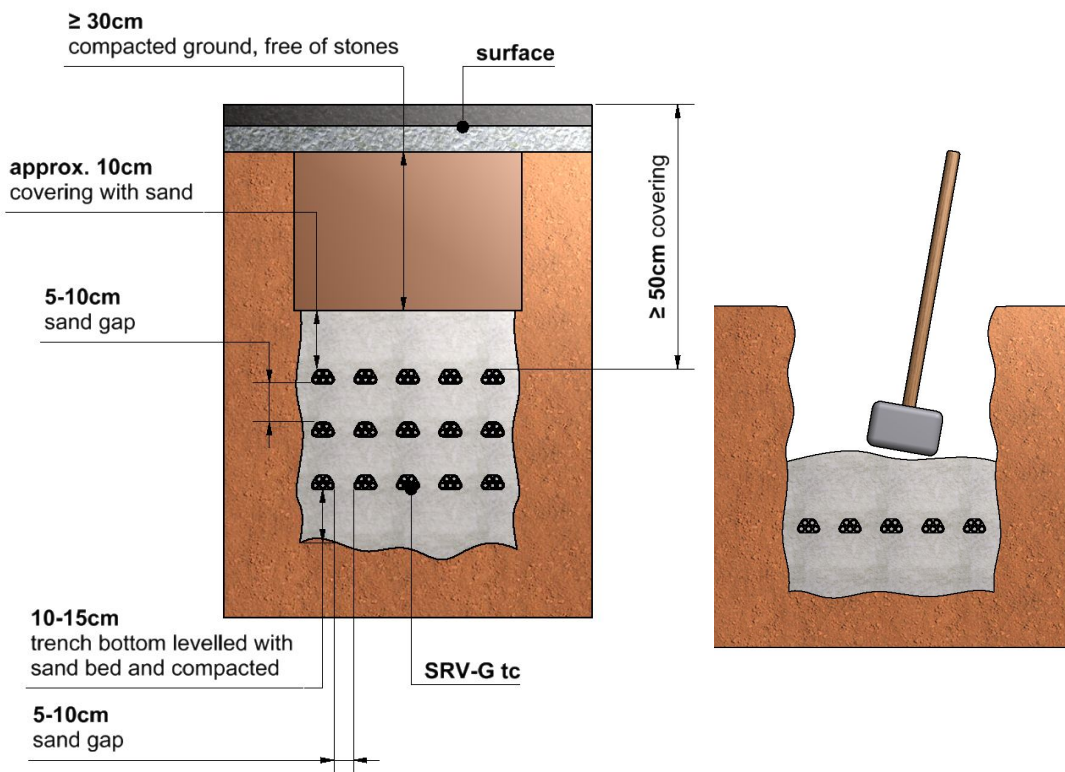

After each layer fill in sand manually (in no case mechanically) and compact.

4.2 Ploughing

The laying of SRV-G tc by means of a plough generally is applicable, if:

- there is no paved surface.
- there are no impediments in the ground.
- the location of external plants is known.
- there are no legal causes of nature conservation to the contrary.

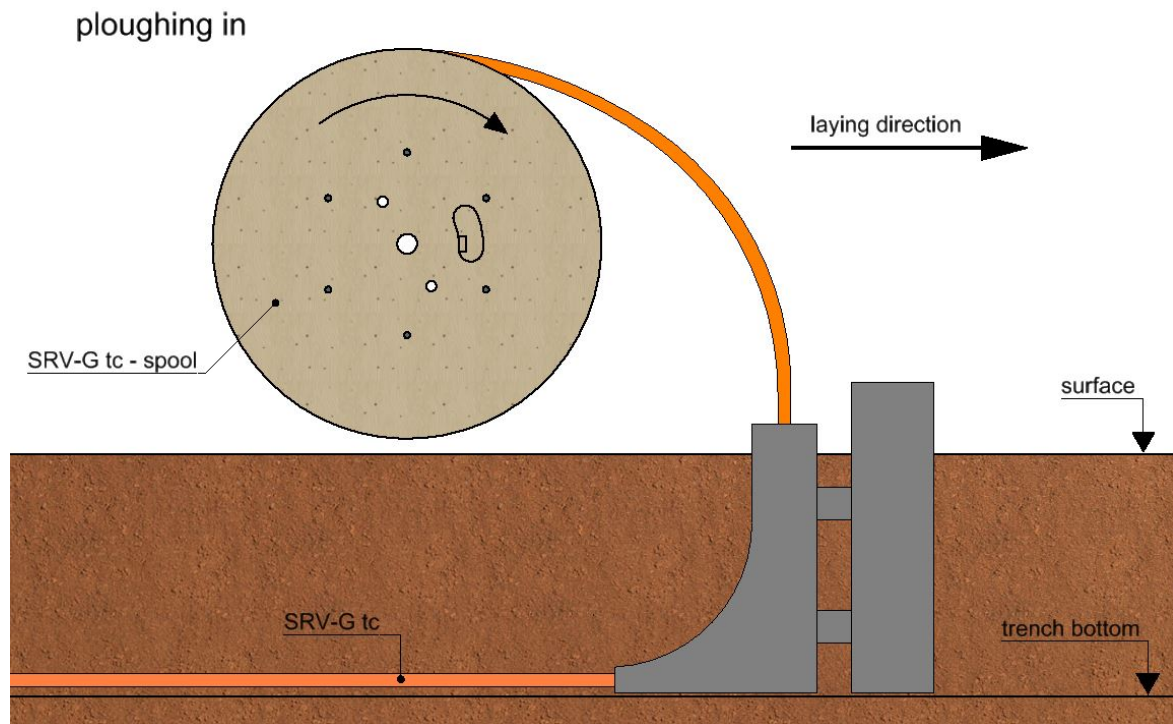

The SRV-G tc must be wound off the coil as described in the illustration (see picture). It is particularly important to respect the linear laying under tension (spool slowed down in controlled manner).

(Besides these laying instructions also possibly existing instructions of the customer concerning the ploughing in of SRV-G tc, ducts or cables must be taken into account.)

4.3 Laying with water drilling



SRV-G tc are suitable for water drilling under following conditions:

- If you work with cable grip, mount it like described under point 3.5:
 - put the coat back
 - displaced cutting of the speedpipe-ground
 - take care for equal power division
 - and so on..
- You can work also with sub duct pulling heads (Vetter)
- Comply with the max. allowed tensile force
- Seal the speedpipe-ground with end plugs ES

We recommend a big enough drilling for an optimal pulling.

4.4 Laying with Micro- and Minitrenching



SRV-G tc are in general suitable for all Micro- and Minitrench techniques. But thitherto there is no relevant long-time experience regarding damage to the road surface and although the influence for SRV-G (tc) and the speedpipe-ground.

We recommend using these techniques on little loaded walkways and streets.

Take care for following conditions:

- The trench bottom have to be free from stones (layed ideally in sand bed)
- Throw no stones on speedpipe®-ground or SRV-G tc
- Linear laying of the SRV-G tc
- Laying under tension
- No twisting of the SRV-G tc
- Realize bending radius so big as possible
- Branch off with controlled bending, e.g. with TBS or LBS
- **Max. Temperature** for SRV-G tc and speedpipe ground is **80°C**.
By sealing with heated pottant (e.g. hot asphalt) the bundle respectively the speedpipe ground have to be protected against temperature. This can be handled for example with a sufficient overlap of sand ($\geq 2\text{cm}$).

5: Pulling SRV-G in existing ducts

By the flexible coating pipe (loose outer jacket) the SRV-G bundles are suitable for pulling into existing duct systems.









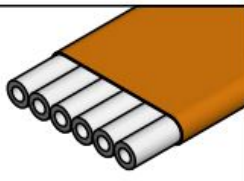
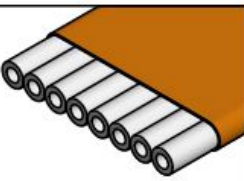
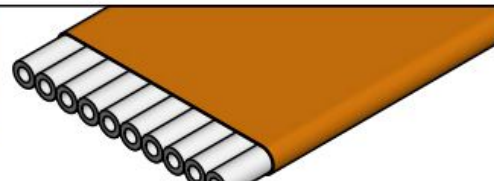
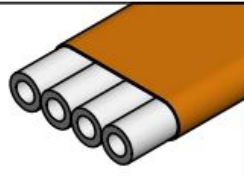
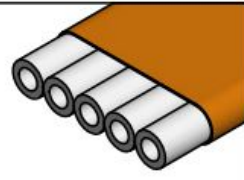

Pay attention to the recommended tensile forces during pulling in bundles and speedpipe (see point 6). Never exceed the recommended tensile forces..

5.1 Pulling in SRV-G in existing ducts (>Ø80mm)

By pulling into existing ducts bigger than 80mm the complete speedpipe® bundle with jacket pipe is installed.

For the occupancy of existing ducts SRV-G can be pulled in by means of a cable grip.

The maximum number of speedpipe bundles shouldn't exceed the expected occupancy of 60% to the inner cross section.

	jacket pipe Ø32	jacket pipe Ø40	jacket pipe Ø50	
7x1,5	 SRV-G 32 / 6x7	 SRV-G 40 / 8x7	 SRV-G 50 / 10x7	
10x2,0	 SRV-G 32 / 4x10	 SRV-G 40 / 5x10	 SRV-G 50 / 7x10	
12x2,0	 SRV-G 32 / 3x12	 SRV-G 40 / 4x12	 SRV-G 50 / 5x12	
14x2,0		 SRV-G 40 / 3x14	 SRV-G 50 / 4x14	 SRV-G 50 / 5x14
16x2,0		 SRV-G 40 / 3x16	 SRV-G 50 / 4x16	

Perparation

- Cleaning the ducts
- Testing and calibrating of the continuity of the duct
- Inserting a lubricant (read the information of the manufacturer)
- Placing the laying carriage with the SRV-G (in linear direction to the manhole)
- Use placement support tools to prevent damages to the coat of the SRV-G (e.g. manhole edge-roller, protection bend for cable)



protection bend



manhole edge-roller

Mounting the cable grip

- gradate speed•pipe[®]-ground and jacket pipe to reach an equal power distribution of the whole SRV-G.
Proceed like this :
 - a) trim the outer coat about 500mm
 - b) buck the speed•pipe[®]-ground in 70mm gradations
- protect every single speed•pipe[®]-ground with end plugs ES or dust caps SK against the penetration of dirt and water.
- fold the end of the jacket pipe tight over the •pipe[®]-ground and fix it with textile tape or similar



- pull the cable grip over the jacket pipe of the speedpipe bundle ground and fix it with textile tape (winding each with 10cm over the cable grip and the outer coat)



Tip:

For reducing the friction during the pulling in process additionally a piece of jacket pipe can be attached over the cable grip.

1.) Pull a piece of jacket pipe over the cable grip

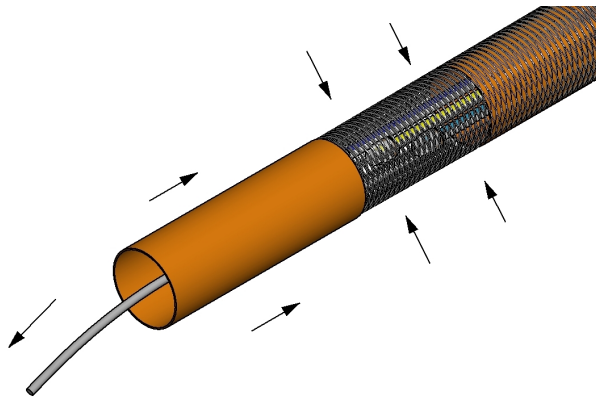

2.) Wrap textile tape over the ends of the covered piece of the jacket pipe

**Pulling in the speedpipe bundle ground**

- The speed pipe bundle ground is pulled in by means of a traction rope or a tube snake.
- Assistance by employees at the coil (e.g. stopping and rotating) as well as at the launching/pulling manhole.
- It is to be avoided that the speed pipe bundle ground is placed at the direct access area of the manholes. Therefore consider the deflection at drawn through or connected SRV-G.
- In case of short distances between the manholes the SRV-G can be drawn through using protection bends and pulling spouts.
- In case the KKR is to be occupied with two speedpipe bundles ground, these can be pulled in one after the other or at the same time.
- The use of lubricant is reducing the pulling in friction

Sealing and fixing the SRV-G to the cable duct conduit

Sealing and fixing the speedpipe bundle ground SRV-G to the KKR 110 in the cable duct is carried out by using the sealing element ADE / TDUX 100 (TE connectivity) and is necessary on both sides in each manhole.



Combined installation of the TE connectivity ADE / TDUX in the KKR 110



Filling and sealing the TE connectivity ADE / TDUX

Tip:







The different occupancy options of the KKR always result in other sealing situations. The company TE connectivity produces different sizes of the ADE / TDUX for being able to seal these different occupancy options. Therefore if necessary identify the right size of the ADE / TDUX so that every junction between the KKR and the SRV-G is filled out (also applies for several SRV-G).

5.2 Pulling in speedpipe®-ground from the SRV-G into existing ducts (Ø32-63mm)

The main advantage is that only one spool has to be handled in comparison with the installation of single ducts.

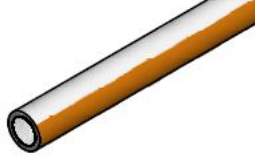
By pulling into existing ducts smaller than 80mm the coating pipe (outer jacket) of the bundle has to be removed by a cutting unit. Only SRV-G bundles with flexible coating pipes (loose outer jacket) can be used!

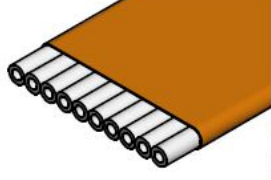
For a maximum occupancy of existing ducts (Ø32, Ø40, Ø50 and Ø63) speedpipe-ground can be pulled in from the SRV-G. The single speedpipe-ground are pulled in with the help of a pulling head. The SRV jacket pipe, before reaching the duct is slit by means of a slicing device and recycled (PE-HD). The reachable pull in length is limited by the permissible tensile force of the speedpipe ground (see table). A positive effect can be achieved by rotating the coil and by using lubricants. The maximum number of speedpipe ground depends on the dimensions of the duct and a possible combination with larger speedpipe ground (see table).

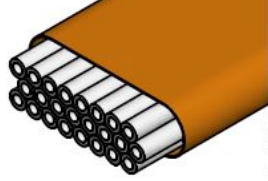
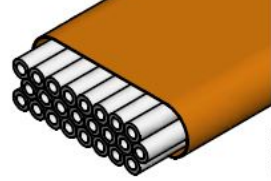
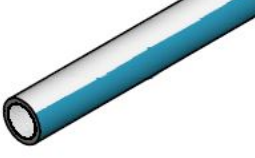
		speed•pipe® 7x1,5		speed•pipe® 7x1,5 + 1 speed•pipe®	
for duct	Ø32x2,9 (2,0)				
		SRV-G 32 / 6x7 3500m / spool max. recommended tensile force: 1800N			
	Ø40x3,7 (2,5)				
		SRV-G 50 / 10x7 3500m / spool max. recommended tensile force: 3000N		SRV-G 40 / 8x7 3500m / spool max. recommended tensile force: 2400N	speed•pipe® 14x2,0 (12x2,0) 1500m (2000m) / spool max. recom. tensile force: 800N (700N)
Ø50x4,6 (3,0)					
	SRV-G 40 / 14x7 3500m / spool max. recommended tensile force: 3900N	SRV-G 50 / 18x7 1800m / spool max. recommended tensile force: 5000N	SRV-G 50 / 10x7 3500m / spool max. recommended tensile force: 3000N	speed•pipe® 14x2,0 (12x2,0) 1500m (2000m) / spool max. recom. tensile force: 800N (700N)	
Ø63x5,8 (4,7)					
	SRV-G 50 / 24x7 1800m / spool max. recommended tensile force: 6500N		SRV-G 50 / 24x7 1800m / spool max. recommended tensile force: 6500N	speed•pipe® 16x2,0 (14x2,0) 1200m (1500m) / spool max. recom. tensile force: 900N (800N)	

Procedure:

1.) Lead the SRV-G through the cutting unit

The complete SRV-G is thread through a cutting unit. In doing so the jacket pipe is lead to a cutter via the guiding element.



cutting unit for jacket pipe
manufacturer Vetter, Lottstetten

2.) Installation pulling head

Cut all speedpipe-ground of the SRV-G evenly and to the same length. The single speedpipe-ground of the SRV-G are screwed together on the face at the appropriate pulling head.

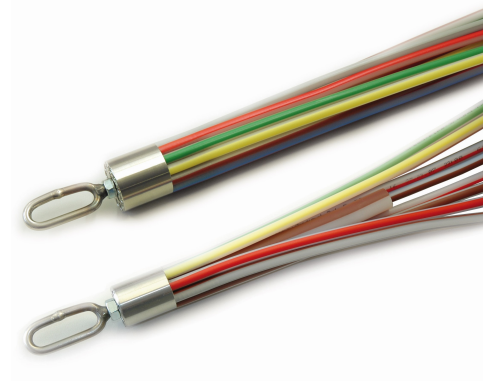

pulling head
manufacturer Vetter, Lottstetten

3.) Pulling in

The pulling head with the single speedpipe-ground is attached to the towing rope and is pulled into the duct. During the pulling in process it is necessary to use lubricants. At the cutting unit the jacket pipe is separated from the speedpipe (the cutting unit must be sufficiently fixed to the ground). The distance from the coil to the cutting unit and from the cutting unit to the duct at least must amount to 5 m.

Principal sketch: Pulling in speedpipe-ground from the SRV-G

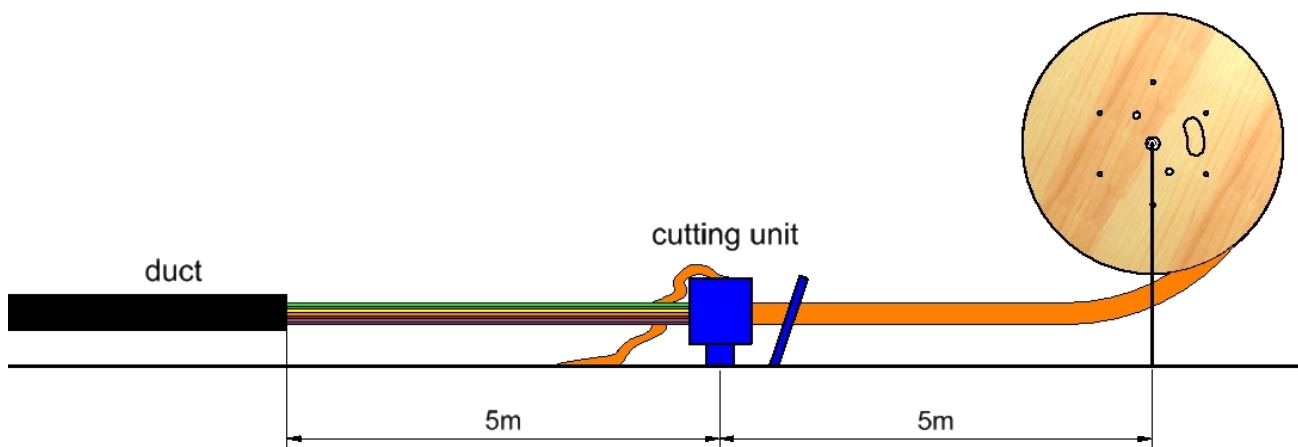

6. Tensile forces

During pulling of bundles the recommended tensile forces have to be respected and may not be exceeded.

Optimum tensile forces are reached at a temperature range from 5° to 20 °C.

For the pulling in process into the duct always use a pulling grip.

In doing so the speedpipe® ground and the jacket pipe must be gradated in a way that a uniform force distribution is reached on the entire speedpipe bundle.

6.1 SRV-G tc variations

Max. recommended tensile strength and tensile strength at break of SRV-G tc in N (at 20°C):

SRV-G tc with speed•pipe®-ground 7 x 1,5	Max. recommended tensile strength (at 20°C)	Tensile strength at break (at 20°C)
SRV-G 2x7 tc	700	900
SRV-G 7x7 tc	1.900	2.800
SRV-G 8x7 + 1x12 tc	3.000	4.100
SRV-G 12x7 tc	3.300	4.800
SRV-G 14x7 tc	3.900	5.600
SRV-G 18x7 tc	5.000	7.300
SRV-G 22x7+1x12 tc	6.600	9.600
SRV-G 24x7 tc	6.500	9.600
SRV-G 24x7 + 1x14 tc	7.200	10.500
SRV-G tc with speed•pipe®-ground 10x2,0		
SRV-G 2x10 tc	1.100	1.400
SRV-G 7x10 tc	3.500	4.700
SRV-G 12x10 tc	5.700	7.900
SRV-G tc with speed•pipe®-ground 12x2,0		
SRV-G 2x12 tc	1.700	1.900
SRV-G 3x12 tc	2.400	2.800
SRV-G 7x12 tc	5.200	6.200
SRV-G tc with speed•pipe®-ground 14x2,0		
SRV-G 2x14 tc	1.800	2.200
SRV-G 3x14 tc	2.800	3.400
SRV-G 4x14 tc	3.700	4.500
SRV-G 5x14 tc	4.500	5.500
SRV-G 7x14 tc	6.000	7.400
SRV-G tc with speed•pipe®-ground 16x2,0		
SRV-G 3x16 tc	3.100	3.900
SRV-G 4x16 tc	4.100	5.100
SRV-G 7x16 tc	6.700	8.600
SRV-G tc with speed•pipe®-ground 20x2,5		
SRV-G 3x20 tc	4.300	5.100
SRV-G 4x20 tc	5.600	6.800

6.2 SRV-G variations

Max. recommended tensile strength and tensile strength at break of SRV-G in N (at 20°C):

SRV-G with speed•pipe®-ground 7 x 1,5	Max. recommended tensile strength (at 20°C)	Tensile strength at break (at 20°C)
SRV-G 32 / 6x7	1.800	2.500
SRV-G 40 / 8x7	2.400	3.400
SRV-G 50 / 10x7	3.000	4.200
SRV-G 40 / 14x7	3.900	5.600
SRV-G 50 / 18x7	5.000	7.300
SRV-G 50 / 24x7	6.500	9.600
SRV-G with speed•pipe®-ground 10x2,0		
SRV-G 32 / 4x10	2.100	2.800
SRV-G 40 / 5x10	2.600	3.400
SRV-G 50 / 7x10	3.500	4.700
SRV-G with speed•pipe®-ground 12x2,0		
SRV-G 32 / 3x12	2.400	2.800
SRV-G 40 / 4x12	3.200	3.700
SRV-G 50 / 5x12	4.000	4.600
SRV-G with speed•pipe®-ground 14x2,0		
SRV-G 40 / 3x14	2.800	3.400
SRV-G 50 / 4x14	3.700	4.500
SRV-G 50 / 5x14	4.500	5.500
SRV-G with speed•pipe®-ground 16x2,0		
SRV-G 40 / 3x16	3.100	3.900
SRV-G 50 / 4x16	4.100	5.100

Max. recommended tensile strength and tensile strength at break of coating pipes in N (at 20°C):

In case only the jacket pipe of the SRV-G is stressed the following tensile forces must not be exceeded.

Name	Max. recommended tensile strength (at 20°C)	Tensile strength at break (at 20°C)
Jacket pipe Ø32	420	600
Jacket pipe Ø40	550	800
Jacket pipe Ø50	700	1.000

7. Laying temperatures

The high-quality material PE-HD of the speedpipe and the jacket pipe allows the laying at temperatures of 10°C below zero. However the optimum conditions are obtained at temperatures between 5° to 20° C. At temperatures below the freezing point we recommend to store the coils with the SRV-G before laying in heated halls for 12 to 24 hours.

Coefficient of linear expansion for PE-HD:

$$16 \times 10^{-5} \times \frac{1}{K}$$

This means, that every increase or decrease of the temperature of the duct by 1 Kelvin (1 K = 1°C) the PE-HD duct shall extend or shorten by 0.16 mm per meter length.

For avoiding tensions in the duct system particularly in midsummer the duct string must be placed in the trench some time before it is filled, to reach an adaption between duct and soil.

	1 Kelvin	10 Kelvin	20 Kelvin	30 Kelvin
1 meter	0,00016 m	0,0016 m	0,0032 m	0,0048 m
10 meter	0,0016 m	0,016 m	0,032 m	0,048 m
100 meter	0,016 m	0,16 m	0,32 m	0,48 m
1000 meter	0,16 m	1,6 m	3,2 m	4,8 m

To counteract against these laws of physics gabocom recommends the utilisation of the appropriate sealing and fixing elements.

8. Opening of speedpipe® bundle ground

We recommend for the opening of a speedpipe® bundle the sheat cutter with sliding guide because there is a lower risk of injury as with a knife for example.

sheat cutter with sliding guide



9. Cutting speedpipe® / speedpipe® bundle ground

For cutting the speedpipe® bundle or the speedpipe® never use chip-producing tools like a saw.

Separate the bundle by means of a pipe cutter. The internal speedpipe must be separated with a speedpipe cutter.

The cutting of the speedpipe for coupling it with a connector (DSM) must be carried out by a straight rectangular cut towards the pipe axis.

Cut speedpipe® that are not coupled with a connector (DSM) afterwards, immediately must be sealed against dirt and the penetration of water by means of a corresponding EZA-t or ES. Please consider the respective assembly instruction for installing the connector.

speedpipe cutter and pipe cutter



Tip:

Uncut speedpipe (without DSM) are the optimal requirement for blowing in a micro cable. So try to make cuts less possible.

Therefore pull the SRV-G in one step if possible e.g. during passing a route of several crossings / courtyard entrances.

10. Bending radius

The least permissible bending radius of the speedpipe® bundle depends on the laying temperature and never must fall below the values specified in the table.

laying temperature	least permissible bending radius of the speedpipe® bundle
20°C	> 1,0m
10°C	> 2,0m
0°C	> 2,5m

The minimum bending radius for speedpipe-ground as an single duct are 10x outer-Ø.
e.g. speedpipe-ground 7x1,5 = minimum bending radius 10x 7mm = 70mm

Tip: Avoid connectors in a bending radius, for these can stop the blowing in process because of the internal edge of the open middle plot.

Recommendation: avoid bending radius < 2,5m

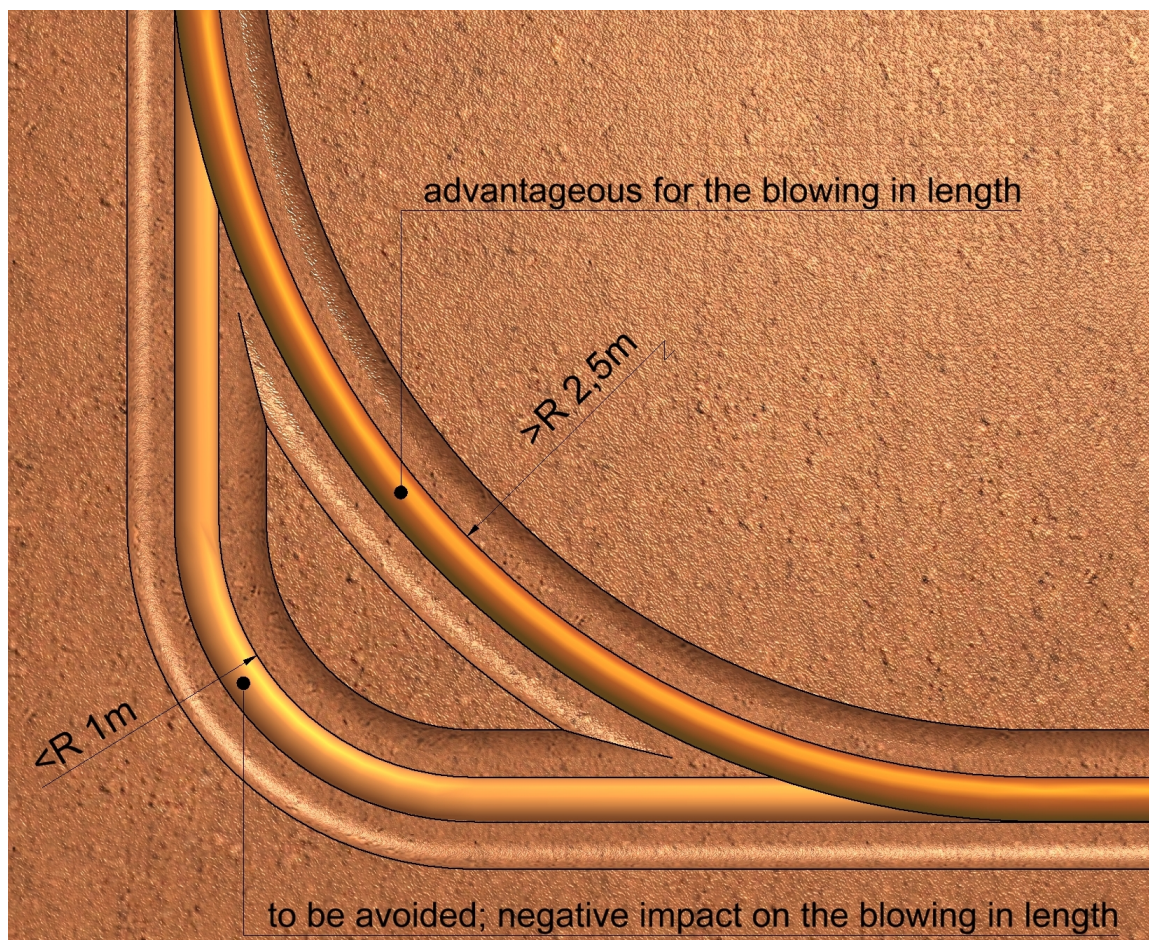

The larger the bending radius the larger the blowing in values afterwards!

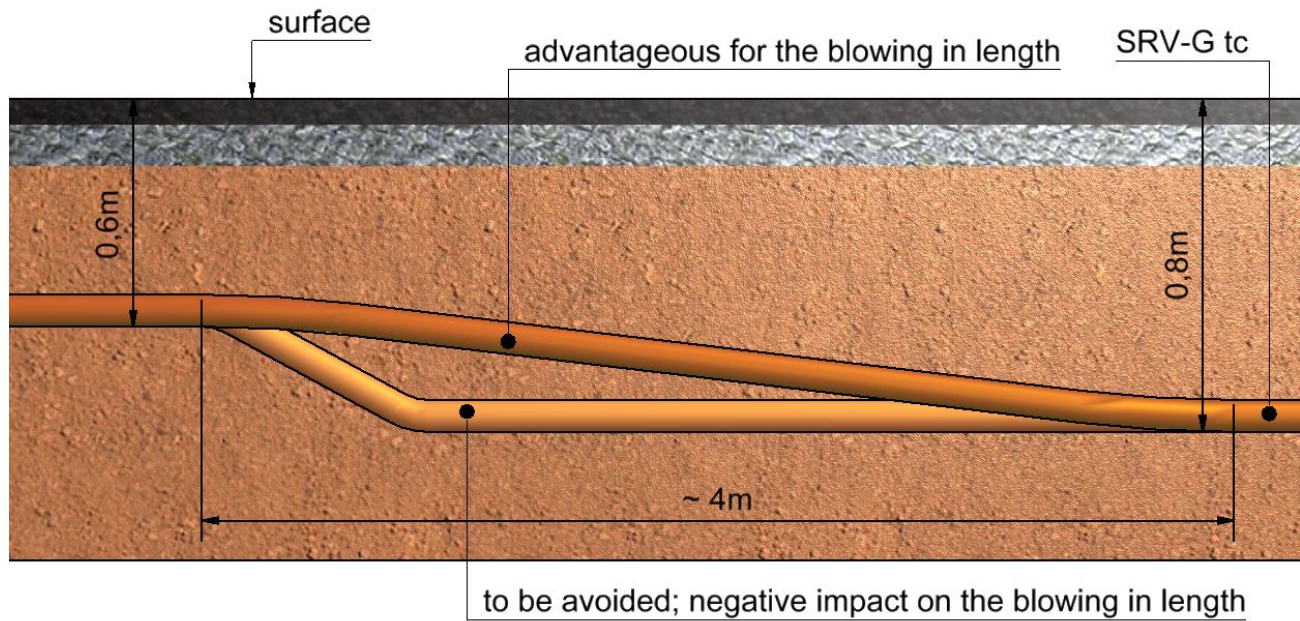

Gently compensate any height difference of the trench bottom. Any rapid height difference will cause a negative impact on the blowing in success!

11. Branching off from the speedpipe® bundle ground

The following branch off procedure is valid for speedpipe-bundles which were laid or plowed in open trenches.

If the speedpipe-bundles were pulled in ducts it is recommended to work with HRMA.

The branching off from the SRV-G should always realize with the help of branch off equipment (TBS/LBS), so it is guaranteed that the minimum bending radius is compliance and also a kinking during the compression process is prevented.

The coat duct of the speedpipe-bundel should opened with a suitable cutting tool (sheat cutter with sliding guide – see point 5) to a length of 80-100cm.

The branching off speedpipe(s) should cutted with a speedpipe-cutter (speedpipe-cutter – see point 6) in front of the branch off equipment and connect it with DSM to the single duct or the branch off speedpipe-bundel.

Fix the speedpipe in the branch off equipment with an cable ties in the prepared holes so the speedpipes are laying in the predefined bending radius..

Optinally can be mounted a ball marker for location on the branch off equipment with cable ties.

Note : **Avoid connectors in a bending radius, for these can stop the blowing in process because of the internal edge of the open middle plot.**

Example of a branch off of a SRV-G 22x7 + 1 x12 tc on a branch off speedpipe-bundel SRV-G 2x7 tc with the branch off equipment TBS:

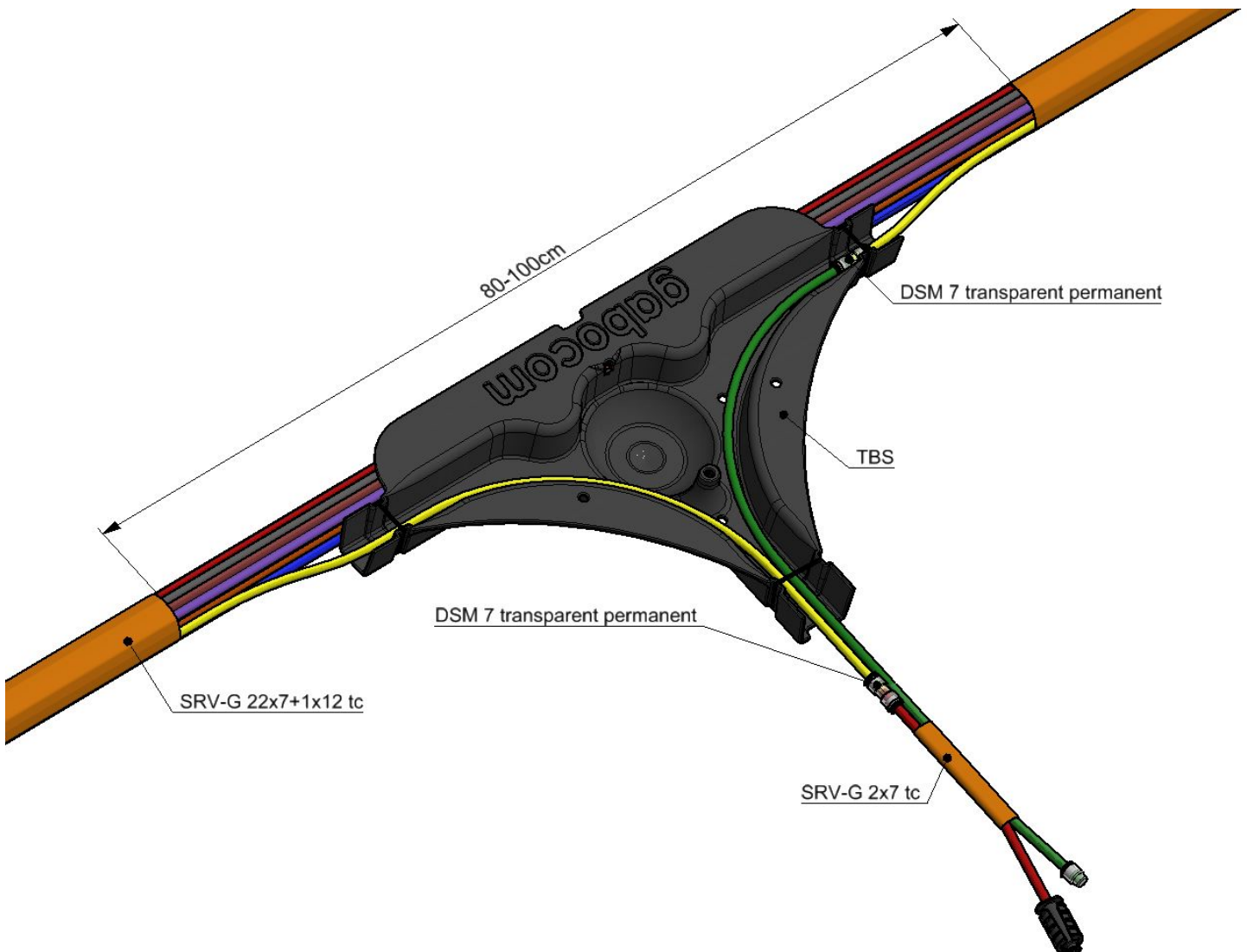

Example of a branch off of a SRV-G 22x7 + 1 x12 tc on a speedpipe-ground 7x1,5 with the branch off equipment LBS:

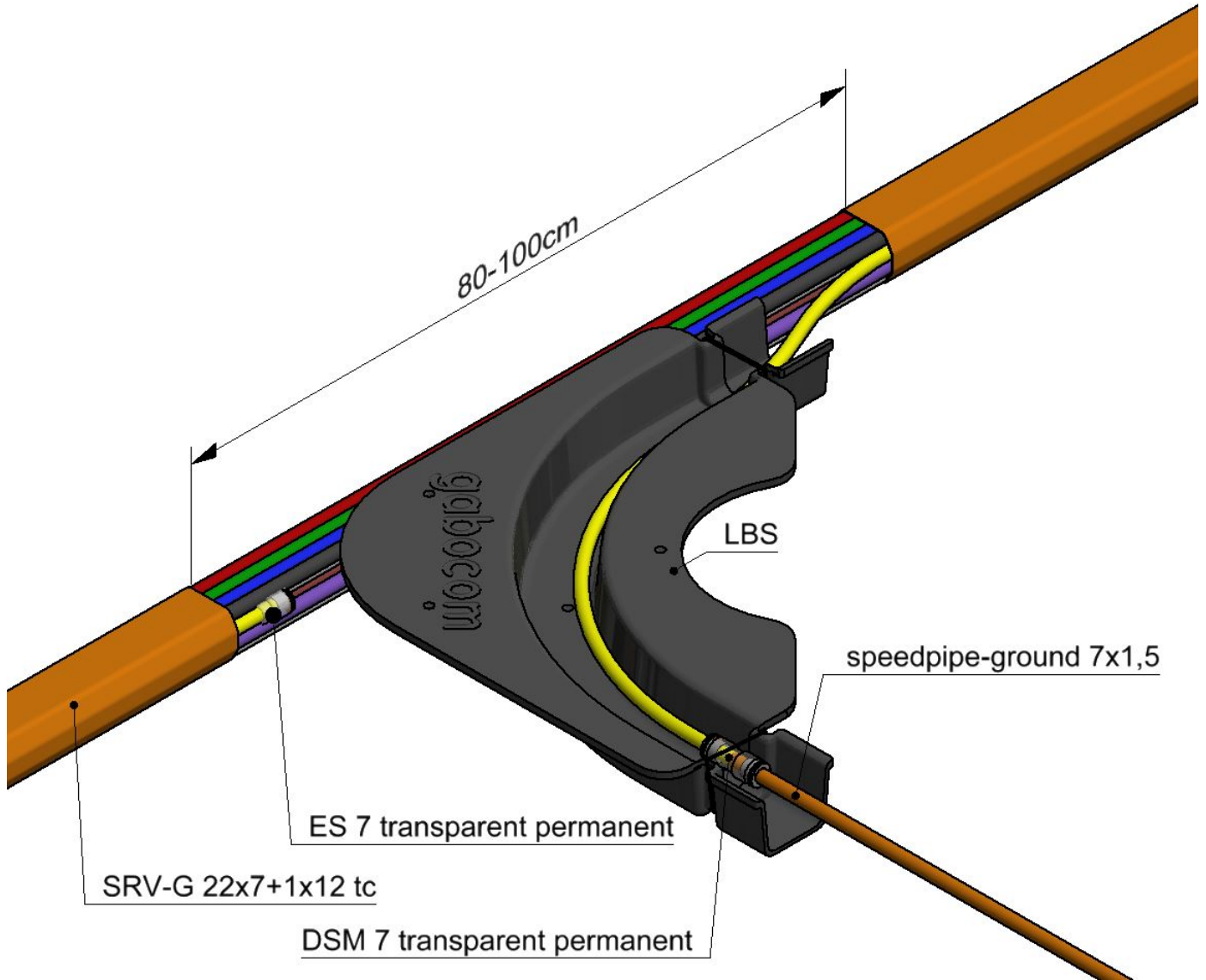

For example branching off from the speedpipe® bundle is necessary for connecting a building. This house connectings can be executed in following ways.

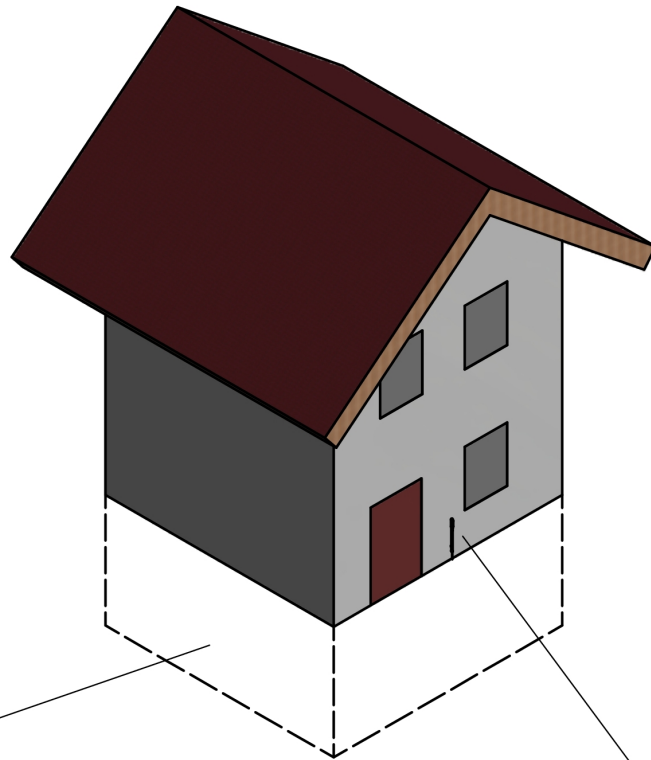

House entrance
use in cellar

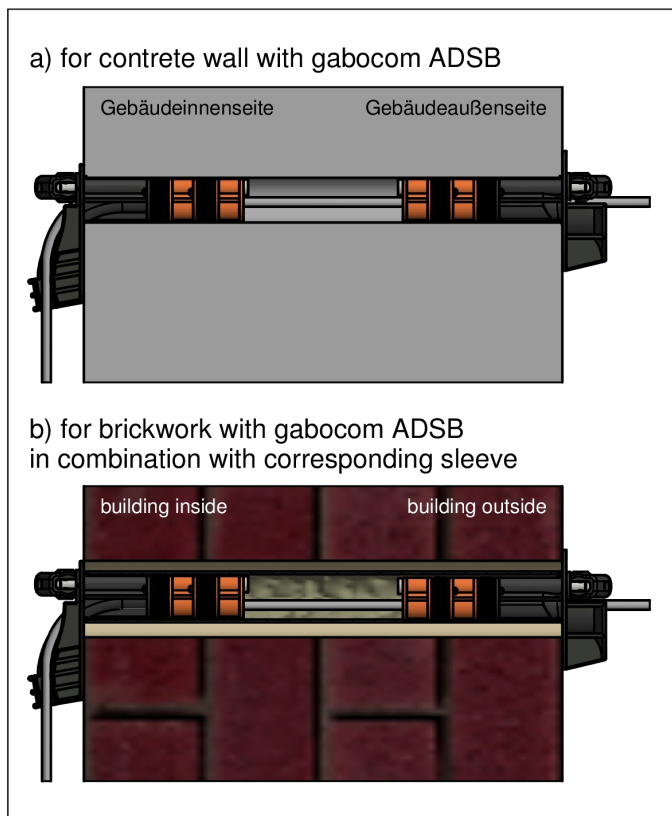

House entrance
overground usage
with gabocom HEO

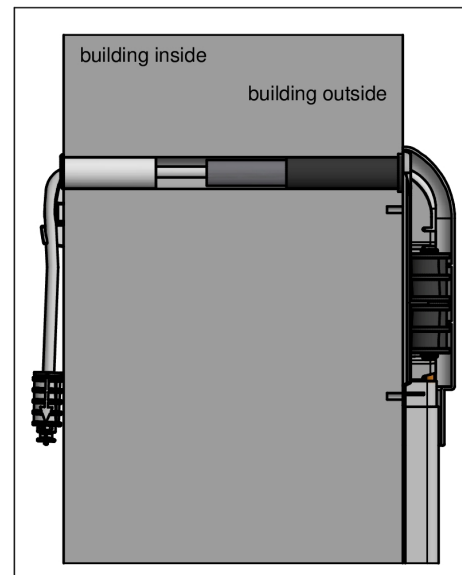

12. Connecting speedpipe® bundle ground

speedpipe-ground of the same colour are interconnected by means of a connector DSM. For this purpose the single speedpipe are to be separated with a speedpipe cutter. It is absolutely important to carry out a straight rectangular cut towards the pipe axis.

Tip: Avoid connectors in a bending radius, because these can stop the blowing in process due to the inside edge of the open middle plot.

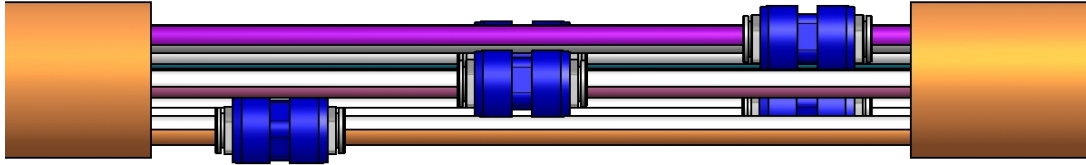

The various coloured speedpipe-ground are variably connected to one another (approx. twice the connector length).

For protecting the joint we recommend to combine the speedpipe-ground by means of a split corrugated pipe PPWR-t 40/50

13. Blowing in micro cables







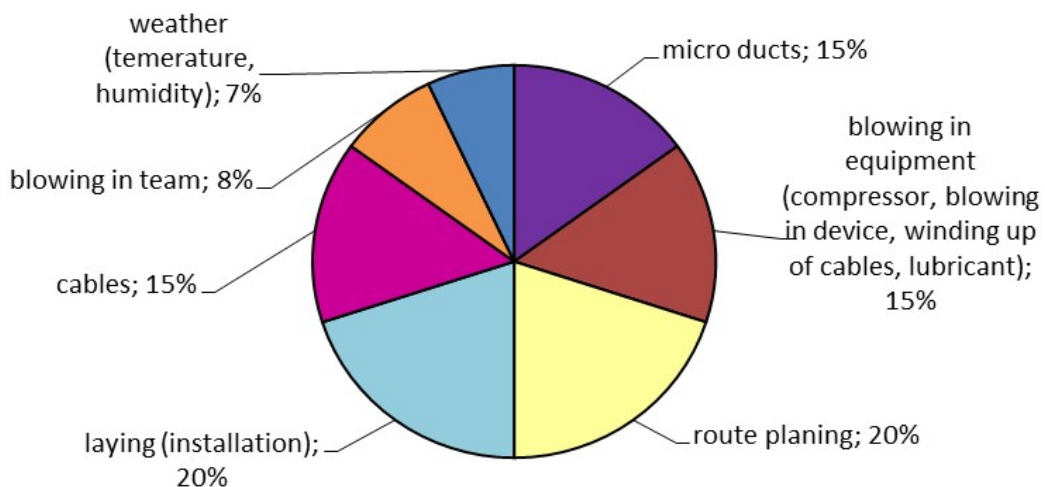

















For blowing in micro cables into the speedpipe that are integrated in the speedpipe® bundle we recommend a blowing in pressure up to 15 bar at the speedpipe®.







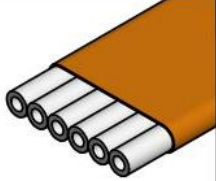

Optimum blowing in values are reached at a temperature range from 5° to 20°C. The cable to be blown in must not be exposed to direct solar radiation.

It might also be helpful to use lubricants that are tested and recommended by specialist companies. The blowing in lengths to be achieved depend on several factors.

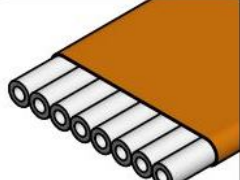
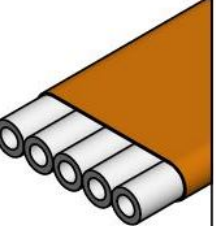
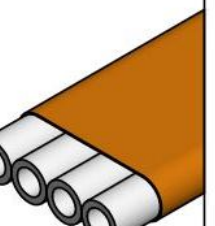
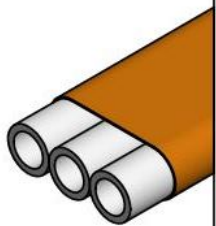

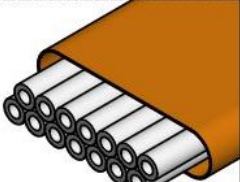
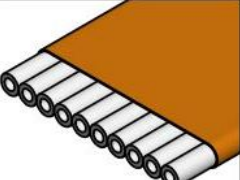
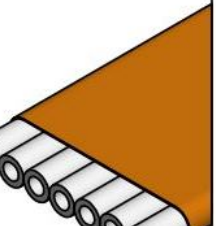
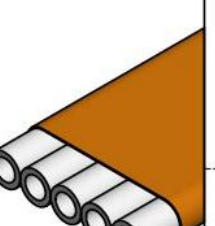
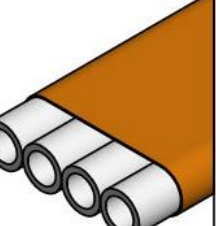
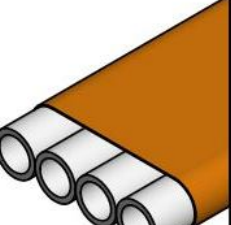
Reference values for blowing in lengths

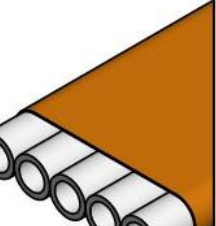
speed-pipe® 7x1,5	speed-pipe® 10x2,0	speed-pipe® 12x2,0	speed-pipe® 14x2,0	speed-pipe® 16x2,0	speed-pipe® 20x2,5
cable diameter					
approx. 2,3mm (12 fibres)	approx. 4,0mm (48 fibres)	approx. 6,2mm (72 fibres)	approx. 8,0mm (96 fibres)	approx. 9,8mm (144 fibres)	approx. 11,5mm (288 fibres)
blow-in length					
up to approx. 1000m	up to approx. 1000m	up to approx. 1300m	up to approx. 1300m	up to approx. 1300m	up to approx. 1300m
					
SRV-G 2x7 tc					
			SRV-G 2x14 tc		
SRV-G 7x7 tc					
	SRV-G 2x10 tc	SRV-G 2x12 tc		SRV-G 3x16 tc	
SRV-G 8x7+1x12 tc					
			SRV-G 3x14 tc		
SRV-G 12x7 tc					
					SRV-G 3x20 tc
SRV-G 14x7 tc					
	SRV-G 7x10 tc	SRV-G 3x12 tc	SRV-G 4x14 tc	SRV-G 4x16 tc	
SRV-G 18x7 tc					
					
SRV-G 22x7+1x12 tc					
			SRV-G 5x14 tc		
SRV-G 24x7 tc					
	SRV-G 12x10 tc	SRV-G 7x12 tc		SRV-G 7x16 tc	SRV-G 4x20 tc
SRV-G 24x7+1x14 tc					

	speed-pipe® 7x1,5	speed-pipe® 10x2,0	speed-pipe® 12x2,0	speed-pipe® 14x2,0	speed-pipe® 16x2,0
	cable diameter				
	approx. 2,3mm (12 fibres)	approx. 4,0mm (48 fibres)	approx. 6,2mm (72 fibres)	approx. 8,0mm (96 fibres)	approx. 9,8mm (144 fibres)
	blow-in length				
	up to approx. 1000m	up to approx. 1000m	up to approx. 1300m	up to approx. 1300m	up to approx. 1300m
jacket pipe Ø32	 SRV-G 32 / 6x7	 SRV-G 32 / 4x10	 SRV-G 32 / 3x12		
jacket pipe Ø40	 SRV-G 40 / 8x7	 SRV-G 40 / 5x10	 SRV-G 40 / 4x12	 SRV-G 40 / 3x14	 SRV-G 40 / 3x16
	 SRV-G 40 / 14x7 tc				
jacket pipe Ø50	 SRV-G 50 / 10x7	 SRV-G 50 / 7x10	 SRV-G 50 / 5x12	 SRV-G 50 / 4x14	 SRV-G 50 / 4x16
	 SRV-G 50 / 18x7 tc			 SRV-G 50 / 5x14	
	 SRV-G 50 / 24x7 tc				

Requirements for achieving optimum blowing in lengths into SRV-G and speedpipe-ground

- **Trench**

- with plane ground (no bumps in the ground)
- as straight as possible
- radius as large as possible – recommended: more than 2,5m (radius of at least 1m)
- as far as possible compensate height differences of 0,1m over a distance of at least 2m

- **SRV-G tc or speedpipe-ground laid in a trench**

- as straight as possible – e.g. along the wall of the trench
- lay the SRV-G tc plane and do not twist
- lay SRV-G tc under tension
- never throw (large) stones onto the SRV-G tc or speedpipe-ground; filling of the trench is to be carried out like the procedure with a direct buriable cable
- mechanical compacting equipment is not allowed until 30 cm depth of coverage
- The later creation of a coiled bundle can have a negative effect on the installation
- compact the ground constantly
- keep integrated speedpipe-ground free of dirt and soil – seal pipe ends!
- wind off the SRV-G tc from the lower side of the coil (see picture referred to in point 3.3)

- **SRV-G tc or speedpipe-ground ploughed**

- for avoiding elongations of the speedpipe-ground due to tensile stress the coil axis must be easily rotatable
- make sure that the coil immediately can be retarded in case of a sudden stop of the plough
- carry out the ploughing as straight as possible
- when changing the direction always keep a radius of at least 2,5 m
- rapid height differences should be avoided
- keep integrated speedpipe-ground free from dirt and soil – seal pipe ends!

The micro cable

- the cable diameter should be within the specified diameter ranges (see table).

speedpipe	min. cable diameter*	max. cable diameter*
7x1,5	1 mm	2,7 mm
10x2,0	1,8 mm	4,6 mm
12x2,0	3 mm	6,8 mm
14x2,0	3 mm	8,7 mm
16x2,0	6,5 mm	10,4 mm
20x2,5	8 mm	12,5 mm

*Including tolerances

- the cable diameter has a significant influence on the blowing in length
- the cable diameter should be uniform and should not vary for more than 0,3 mm
- the cable sheath should be as smooth as possible
- the surface of the micro cable should be dry and clean and should not exceed temperatures of more than 25°C (ideal 15°C)
- the micro cable ideally has been optimised to the gabocom-speedpipe and has been certified on a test track
- the cable shouldn't have any axial run out

- **Blowing in the micro cable**

- the coil of the micro cable must be easily rotatable
- make sure that the coil immediately can be retarded in case of a unexpected stop
- ensure cleanness of the micro cable
- clean the speedpipe (inside) with a clean cylindrical sponge
- only use an appropriate blowing in device (e.g. Vetter)
- use a compressor with strong airflow, with max. pressure of 15 bar (1000 l/m for speedpipe up to an internal diameter of 12 mm
- the airflow out of the compressor must be clean, oil-free, dry and cooled down by using a re-cooler to approx. 8°C - 10°C over environmental temperature
- the maximum blowing in speed should be limited to 80 m/min
- use appropriate lubricants
- according to the common rules the permissible range of the blowing-in temperature amounts from -2°C to +37°C
- the utilisation of a „Lubricator“ for a permanent wetting of the micro cable with lubricants has a positive impact on the blowing in speed and blowing in length
- mount a cable conduct head on the top of the cable

- **Lubricant**

- pay attention to the correct dosing according to the manufacturer's data
- before blowing in the micro cable the lubricant must be spread in the speedpipe by means of a cylindrical sponge.

Source: Manufacturer Vetter Lottstetten

14. Photographs from practice

14.1 SRV-G to open trench

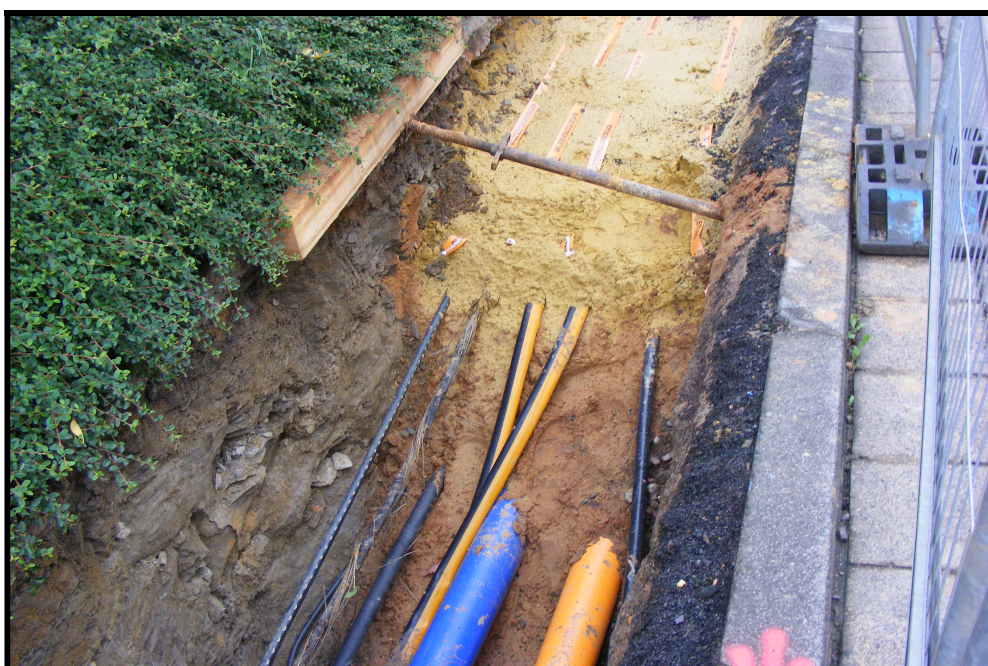



14.2 Ploughing



14.3 Pulling in speedpipe-ground from the SRV-G into existing ducts

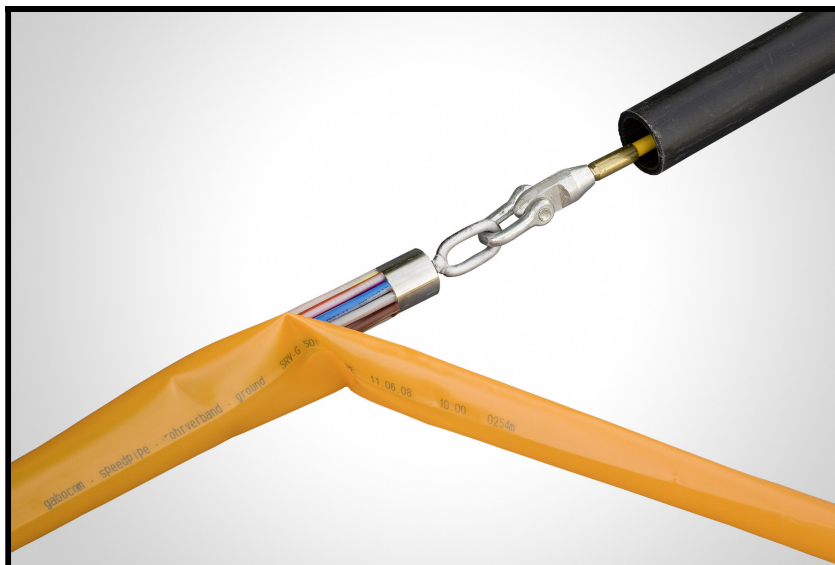

15. Colour code

15.1 Colour code gabocom

colour code gabocom	speedpipe-ground 7x1,5 (7/4)	
	no.	colour
	1	red / yellow (<i>SRV-G 2x7 tc: red</i>)
	2	red / green (<i>SRV-G 2x7 tc: green</i>)
	3	red / blue
	4	red / violet
	5	red / grey
	6	yellow / blue
	7	yellow / violet
	8	yellow / grey
	9	green / blue
	10	green / violet
	11	green / grey
	12	brown / blue
	13	brown / violet
	14	brown / grey
	15	brown / green
	16	brown / yellow
	17	brown / red
	18	black / red
	19	black / yellow
	20	black / green
	21	black / blue
	22	black / violet
23	black / grey	
24	black / brown	

colour code gabocom	speedpipe-ground 10x2,0 (10/6)	
	no.	colour
	1	black
	2	brown
	3	red
	4	orange
	5	yellow
	6	green
	7	blue
	8	violet
	9	grey
	10	white
	11	turquoise
12	pink	

colour code gabocom	speedpipe-ground 12x2,0 (12/8)	
	no.	colour
	1	black
	2	brown
	3	red
	4	orange
	5	yellow
	6	green
7	blue	

colour code gabocom	speedpipe-ground 14x2,0 (14/10)	
	no.	colour
	1	black
	2	brown
	3	red
	4	orange
	5	yellow
	6	green
7	blue	

colour code gabocom	speedpipe-ground 16x2,0 (16/12)	
	no.	colour
	1	black
	2	brown
	3	red
	4	orange
	5	yellow
	6	green
	7	blue

colour code gabocom	speedpipe-ground 20x2,5 (20/15)	
	no.	colour
	1	black
	2	brown
	3	red
4	orange	

15.2 Colour code DIN

colour code DIN	speedpipe-ground 7x1,5 (7/4)	
	no.	colour
	1	red / 2 colour strips
	2	green / 2 colour strips
	3	blue / 2 colour strips
	4	yellow / 2 colour strips
	5	white / 2 colour strips
	6	grey / 2 colour strips
	7	brown / 2 colour strips
	8	violet / 2 colour strips
	9	turquoise / 2 colour strips
	10	black / 2 colour strips
	11	orange / 2 colour strips
	12	pink / 2 colour strips
	13	red / 4 colour strips
	14	green / 4 colour strips
	15	blue / 4 colour strips
	16	yellow / 4 colour strips
	17	white / 4 colour strips
	18	grey / 4 colour strips
	19	brown / 4 colour strips
	20	violet / 4 colour strips
	21	turquoise / 4 colour strips
	22	black / 4 colour strips
23	orange / 4 colour strips	
24	pink / 4 colour strips	

colour code DIN	speedpipe-ground 10x2,0 (10/6)	
	no.	colour
	1	red
	2	green
	3	blue
	4	yellow
	5	white
	6	grey
	7	brown
	8	violet
	9	turquoise
	10	black
	11	orange
12	pink	

colour code DIN	speedpipe-ground 12x2,0 (12/8)	
	no.	colour
	1	red
	2	green
	3	blue
	4	yellow
	5	white
	6	grey
	7	brown

colour code DIN	speedpipe-ground 14x2,0 (14/10)	
	no.	colour
	1	red
	2	green
	3	blue
	4	yellow
	5	white
	6	grey
	7	brown

colour code DIN	speedpipe-ground 16x2,0 (16/12)	
	no.	colour
	1	red
	2	green
	3	blue
	4	yellow
	5	white
	6	grey
	7	brown

colour code DIN	speedpipe-ground 20x2,5 (20/15)	
	no.	colour
	1	red
	2	green
	3	blue
4	yellow	