

018632-000 | FIST-GC02-BE16-NN



FIST® GC02 Fiber Optic Splice Closure, Heat Shrink or Gold Gel Cable sealing, size BE, no pre-installed fiber trays, 16 round ports + 1 oval port

- Single-ended, O-ring sealed dome closure for splicing feeder and distribution cables
- Compatible with most common cable types: e.g. loose tube, central core, ribbon fiber
- Universal mounting system (UMS) profiles provide foundation for mounting combinations of FIST splice trays
- Closure can be used in aerial, pedestal and underground (up to 5 meters) environments
- Compatible with CommScope's CWDM modules and optical splitter trays

Product Classification

Regional Availability	EMEA
Product Type	Single-ended, round fiber closure
Product Brand	FIST®
Product Series	FIST-GC02

General Specifications

Cable Entry Drop Port Style	Round
Cable Entry Main Port Style	Oval
Cable Ports Quantity, total	1 oval port (2 cables) + 16 round ports
Cable Sealing Type	Gel kit (optional) Heat shrink
Closure Sealing Type	Dome-to-base clamp with O-ring
Closure Style	Single-ended
Color	Black
Mounting	Pole Strand Wall
Network Area Type	Distribution
Splice Tray Included, quantity	0
Splicing Capacity, Mass Fusion, maximum	1728
Splicing Capacity, Single Fusion, maximum	1344
Splicing Type, Supported	Mass fusion Single fusion

Dimensions

Length	680 mm 26.772 in
Cable Entry Drop Port Diameter	20 mm 0.787 in

018632-000 | FIST-GCO2-BE16-NN

Diameter	247 mm 9.724 in
Diameter, with clamp	285 mm 11.22 in
Main Cable Diameter, maximum	25 mm 0.984 in

Dimension Drawing

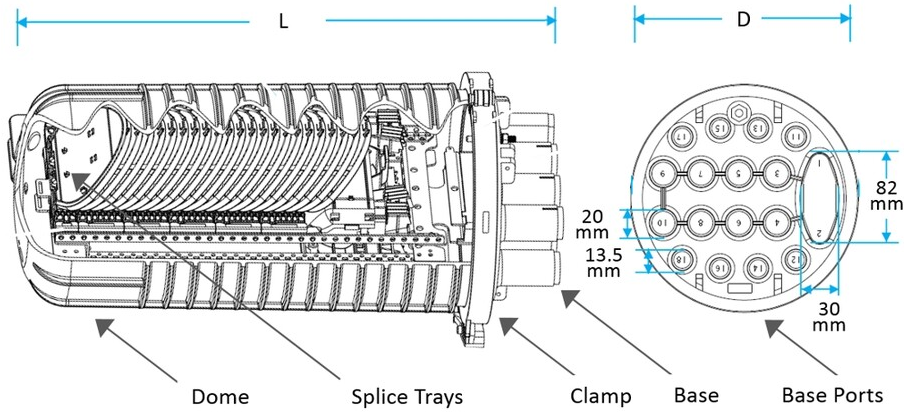

	FIST-GCO2-BC	FIST-GCO2-BD	FIST-GCO2-BE	FIST-GCO2-BE
Length L	488 mm/19.213 in	566 mm/22.283 in	680 mm/26.772 in	795 mm/31.30 in
Width D at base	247 mm/9.724 in	247 mm/9.724 in	247 mm/9.724 in	247 mm/9.724 in
Width D at base with clamp	285 mm/11.22 in	285 mm/11.22 in	285 mm/11.22 in	285 mm/11.22 in

Port Configuration

	Cables per port	Cable Diameter, min	Cable Diameter, max
1 Oval Port	2	12 mm / 0.472 in	25 mm / 0.984 in
16 Round Ports	1	5 mm / 0.197 in	20 mm / 0.787 in

Splicing Configuration

	FIST-GCO2-BC	FIST-GCO2-BD	FIST-GCO2-BE	FIST-GCO2-BE
UMS Units	2x28	2x42	2x58	2x64
# SC/SLE 4mm trays	56	80	112	128
# SE 8mm trays	28	40	56	64
# R12 12mm Flat ribbon trays	18	26	36	42
Max single splice capacity SC trays (4F/tray)	224	320	448	512
Max single splice capacity SE trays (12F/SE)	336	480	672	768
Max single splice capacity High dense tray (12F/SLE)	672	960	1344	1536
Max mass splice capacity R12 trays (Flat ribbon)	432	624	864	1008
Max mass splice capacity SE trays (Rollable ribbon G657A2 fiber)	1008	1440	1728	1728

018632-000 | FIST-GCO2-BE16-NN

Ordering Tree

FIST-GCO2- _____ - _____

Closure size

BC	488 mm long with (2) 28 unit UMS
BD	566 mm long with (2) 42 unit UMS
BE	680 mm long with (2) 58 unit UMS
BF	795 mm long with (2) 64 unit UMS

Number of ports

6	Round ports	(6 : ø 30) + 1 oval port
8	Round ports	(8 : ø 30) + 2 oval ports
16	Round ports	(8 : ø 20) + 1 oval port (8 : ø 13.5)

Flash test valve

V	Pre-installed flash test valve
N	No flash test valve

Ground feed-through

G	Pre-installed ground feedthrough
N	No ground feedthrough

Material Specifications

Material Type

Impact-resistant polymer

Environmental Specifications

Environmental Space

Below ground | Buried

Qualification Standards

IEC 61300, 5 m waterhead

Packaging and Weights

Packaging quantity

1

Packaging Type

Box | Carton

Weight, net

6.7 kg | 14.771 lb

Regulatory Compliance/Certifications

Agency

Classification

CHINA-ROHS

Below maximum concentration value

ISO 9001:2015

Designed, manufactured and/or distributed under this quality management system

REACH-SVHC

Compliant as per SVHC revision on www.commscope.com/ProductCompliance

ROHS

Compliant

